

AIR CONDITIONER

Wall mounted type

DESIGN & TECHNICAL MANUAL

INDOOR



ASYH30KMTB
ASYH36KMTB

OUTDOOR



AOYH30KMTB
AOYH36KMTB

FUJITSU GENERAL LIMITED

Notices:

- Product specifications and design are subject to change without notice for future improvement.
- For further details, please check with our authorized dealer.

Trademarks

FGLair™ is trademark of Fujitsu General Limited in the United States, other countries or both.

Google Play™ is trademark of Google LLC.

App Store® is a service mark of Apple Inc., registered in the U.S. and other countries.

CONTENTS

Part 1. INDOOR UNIT	1
1. Specifications	2
2. Dimensions	4
2-1. Models: ASYH30KMTB and ASYH36KMTB	4
3. Wiring diagrams	6
3-1. Models: ASYH30KMTB and ASYH36KMTB	6
4. Capacity table	7
4-1. Cooling capacity.....	7
4-2. Heating capacity	8
5. Fan performance	9
5-1. Air velocity distributions.....	9
5-2. Airflow	10
6. Operation noise (sound pressure)	11
6-1. Noise level curve.....	11
6-2. Sound level check point	12
7. Safety devices	13
8. External input and output	14
8-1. External input.....	15
8-2. External output.....	18
8-3. Setting of external input and output	20
8-4. Details of control input function	21
8-5. Details of control output function	25
9. Group connection	27
10. Remote controller	28
10-1. Wireless remote controller	28
11. Function settings	30
11-1. Function settings by using remote controller	30
11-2. Custom code setting for wireless remote controller.....	36
12. Accessories	37
13. Optional parts	38
13-1. Controllers	38
13-2. Others	39

CONTENTS (continued)

Part 2. OUTDOOR UNIT	41
1. Specifications	42
2. Dimensions	43
2-1. Models: AOYH30KMTB and AOYH36KMTB	43
3. Installation space	44
3-1. Models: AOYH30KMTB and AOYH36KMTB	44
4. Refrigerant circuit	48
4-1. Models: AOYH30KMTB and AOYH36KMTB	48
5. Wiring diagrams	49
5-1. Models: AOYH30KMTB and AOYH36KMTB	49
6. Capacity compensation rate for pipe length and height difference	50
6-1. Model: AOYH30KMTB	50
6-2. Model: AOYH36KMTB	51
7. Additional charge calculation	52
7-1. Models: AOYH30KMTB and AOYH36KMTB	52
8. Airflow	53
8-1. Models: AOYH30KMTB and AOYH36KMTB	53
9. Operation noise (sound pressure)	54
9-1. Noise level curve.....	54
9-2. Sound level check point	55
10. Electrical characteristics	56
11. Safety devices	57
12. External input and output	58
12-1.External input	58
12-2.External output.....	60
13. Function settings	62
13-1.Control PCB and switch buttons location	62
13-2.Local setting procedure.....	64
14. Accessories	66
14-1.Models: AOYH30KMTB and AOYH36KMTB	66
15. Optional parts	67

Part 1. INDOOR UNIT

WALL MOUNTED TYPE:

ASYH30KMTB

ASYH36KMTB

1. Specifications

Type				Wall mounted				
				Inverter heat pump				
Model name				ASYH30KMTB	ASYH36KMTB			
Power supply				230 V~50 Hz				
Power supply intake				Outdoor unit				
Available voltage range				198—264 V				
Capacity	Cooling	Rated	kW	8.0	9.4			
			Btu/h	27,300	32,100			
		Min.—Max.	kW	2.9—9.0	2.9—10.0			
	Btu/h		9,900—30,700	9,900—34,100				
	Heating	Rated	kW	8.8	10.1			
			Btu/h	30,000	34,500			
Min.—Max.		kW	2.2—11.8	2.7—12.6				
	Btu/h	7,500—40,200	9,200—42,900					
Input power	Cooling	Rated	kW	2.33	3.16			
				Min.—Max.	0.54—3.86	0.54—4.30		
		Heating	Rated	kW	2.20	2.73		
	Min.—Max.				0.48—4.23	0.48—4.30		
	Fan	HIGH	MED	LOW	QUIET	W		
							62.0	
							36.5	
							21.0	
					11.5			
Current	Cooling	Rated	A	10.2	13.9			
	Heating			9.7	12.0			
Energy efficiency class	Cooling			A ⁺⁺				
	Heating (Average)			A ⁺				
Pdesign	Cooling		kW	8.00	9.40			
	Heating (Average)			6.50	7.10			
SEER	Cooling		kWh/kWh	6.68	6.10			
SCOP	Heating (Average)			4.50				
Annual energy consumption	QCE		kWh/a	419	534			
	QHE (Average)			1,994	2,189			
EER	Cooling		kW/kW	3.43	2.97			
COP	Heating			4.00	3.70			
Sensible capacity	Cooling		kW	6.15	6.70			
Power factor	Cooling		%	99				
	Heating			99				
Moisture removal			L/h (pints/h)	2.6 (4.6)	3.8 (6.7)			
Maximum operating current*1	Cooling		A	21.0	21.5			
	Heating			21.0	21.5			
Fan	Airflow rate	Cooling	HIGH	MED	LOW	QUIET	m ³ /h	1,330
								1,100
								920
								720
		Heating	HIGH	MED	LOW	QUIET	1,330	
							1,100	
							920	
							720	
	Type × Q'ty	Cross flow fan × 1						
	Motor output	W						
Sound pressure level*2	Cooling	HIGH	MED	LOW	QUIET	dB (A)	50	
							44	
							40	
							33	
	Heating	HIGH	MED	LOW	QUIET	49		
						44		
						39		
						33		
						65		
						65		
Heat exchanger	Dimensions (H × W × D)		mm	Main: 448 × 900 × 30 Sub1: 84 × 900 × 13.3 Sub2: 126 × 900 × 13.3				
	Fin pitch			Main: 1.2, Sub: 1.4				
	Rows × Stages			Main: 3 × 28, Sub1: 1 × 4, Sub2: 1 × 6				
	Pipe type			Copper tube				
	Fin type			Aluminum				
	Material			Polystyrene				
Enclosure	Material		Polystyrene					
	Color		White Approximate color of Munsell N9.25/					
Dimensions (H × W × D)	Net		mm	340 × 1,150 × 280				
	Gross			405 × 1,270 × 450				
Weight	Net		kg	18.5				
	Gross			24.5				
Connection pipe	Size	Liquid	mm (in)	Ø 9.52 (Ø 3/8)				
		Gas		Ø 15.88 (Ø 5/8)				
	Method		Flare					
Drain hose	Material		PVC					
	Tip diameter		mm					
Operation range	Cooling		°C	18 to 32				
	Heating		%RH	80 or less				
			°C	16 to 30				
Remote controller	Wireless or Mobile app (FGLair™I*3) (Wired [option])							

Type	Wall mounted	
	Inverter heat pump	
Model name	ASYH30KMTB	ASYH36KMTB
<p>NOTES:</p> <ul style="list-style-type: none"> • Specifications are based on the following conditions: <ul style="list-style-type: none"> – Cooling: Indoor temperature of 27 °CDB/19 °CWB, and outdoor temperature of 35 °CDB/24 °CWB. – Heating: Indoor temperature of 20 °CDB/15 °CWB, and outdoor temperature of 7 °CDB/6 °CWB. – Pipe length: 5.0 m, Height difference: 0 m. (Between outdoor unit and indoor unit.) • Protective function might work when using it outside the operation range. • *1: Maximum operating current is the total current of the indoor unit and the outdoor unit. • *2: Sound pressure level: <ul style="list-style-type: none"> – Measured values in manufacturer's anechoic chamber. – Because of the surrounding sound environment, the sound levels measured in actual installation conditions might be higher than the specified values here. • *3: Available on Google Play store or on App Store. For details, refer to the setting manual. • This data is based on EN 14511 standard. 		

2. Dimensions

2-1. Models: ASYH30KMTB and ASYH36KMTB

Unit: mm

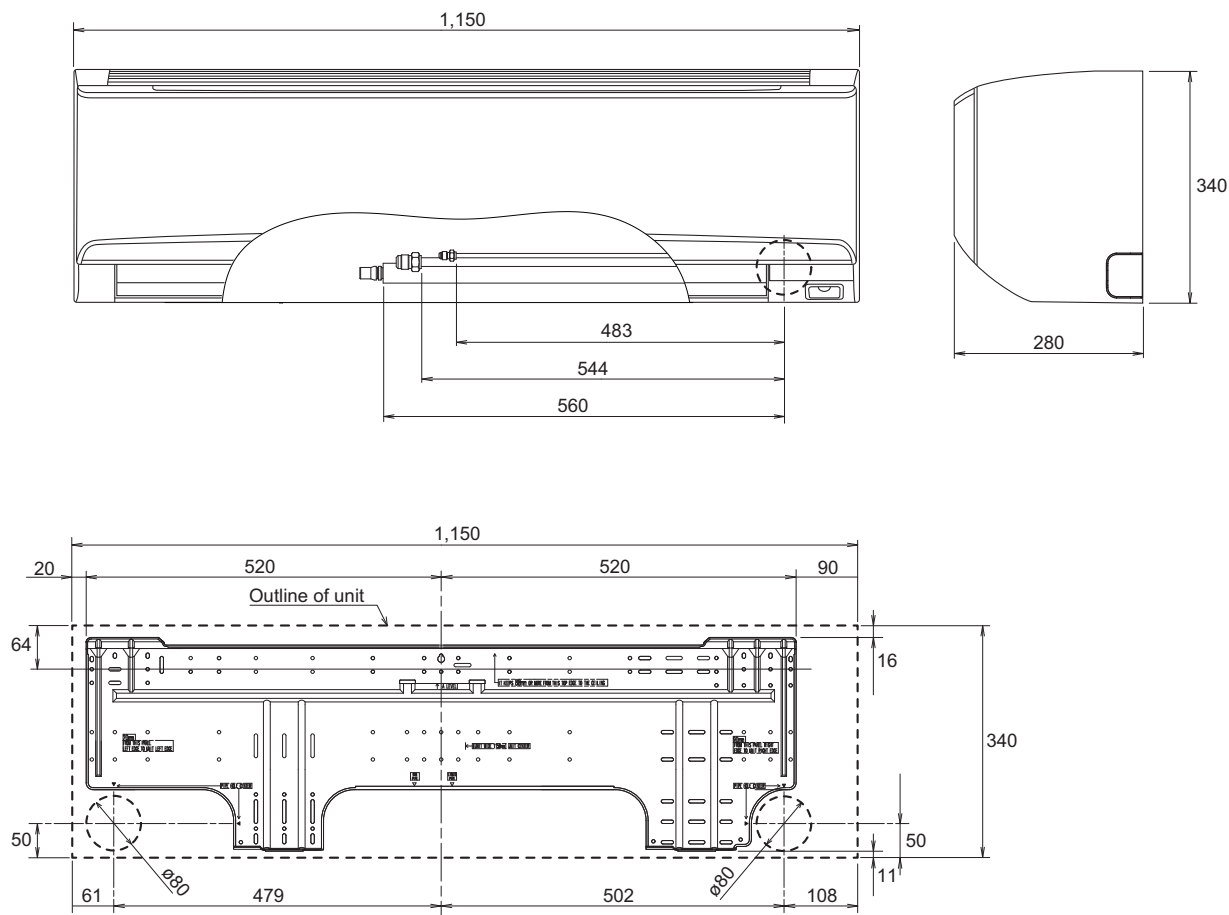

Installation space requirement

Provide sufficient installation space for product safety.

Unit: mm

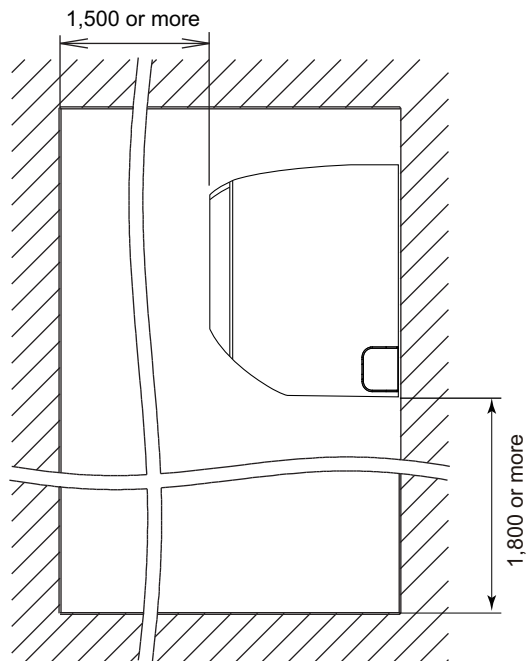
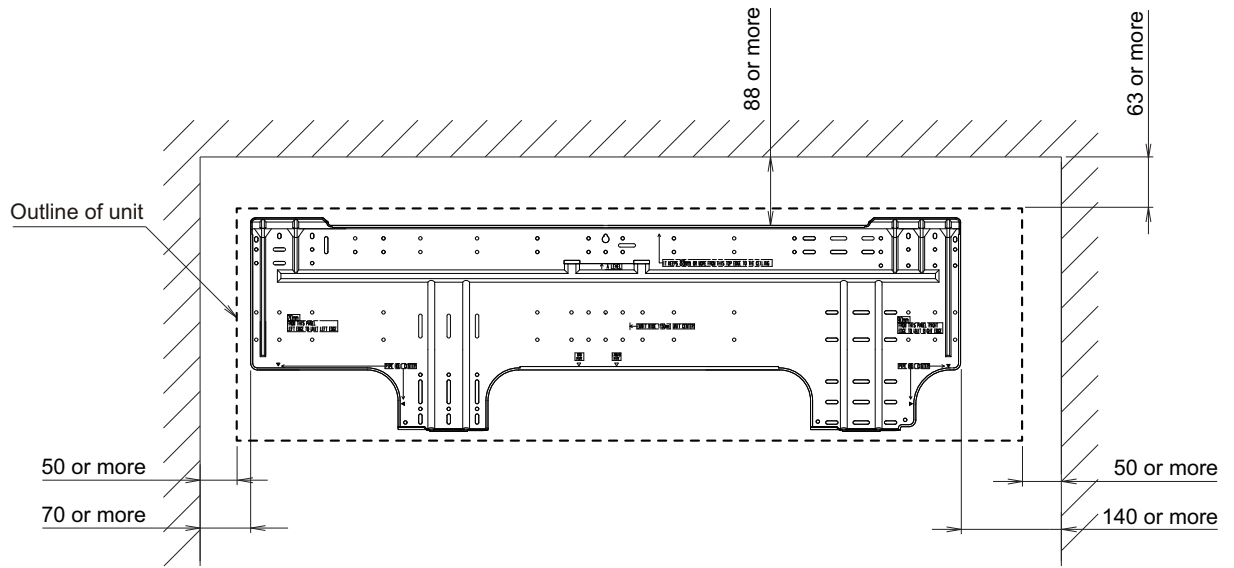

3. Wiring diagrams

3-1. Models: ASYH30KMTB and ASYH36KMTB

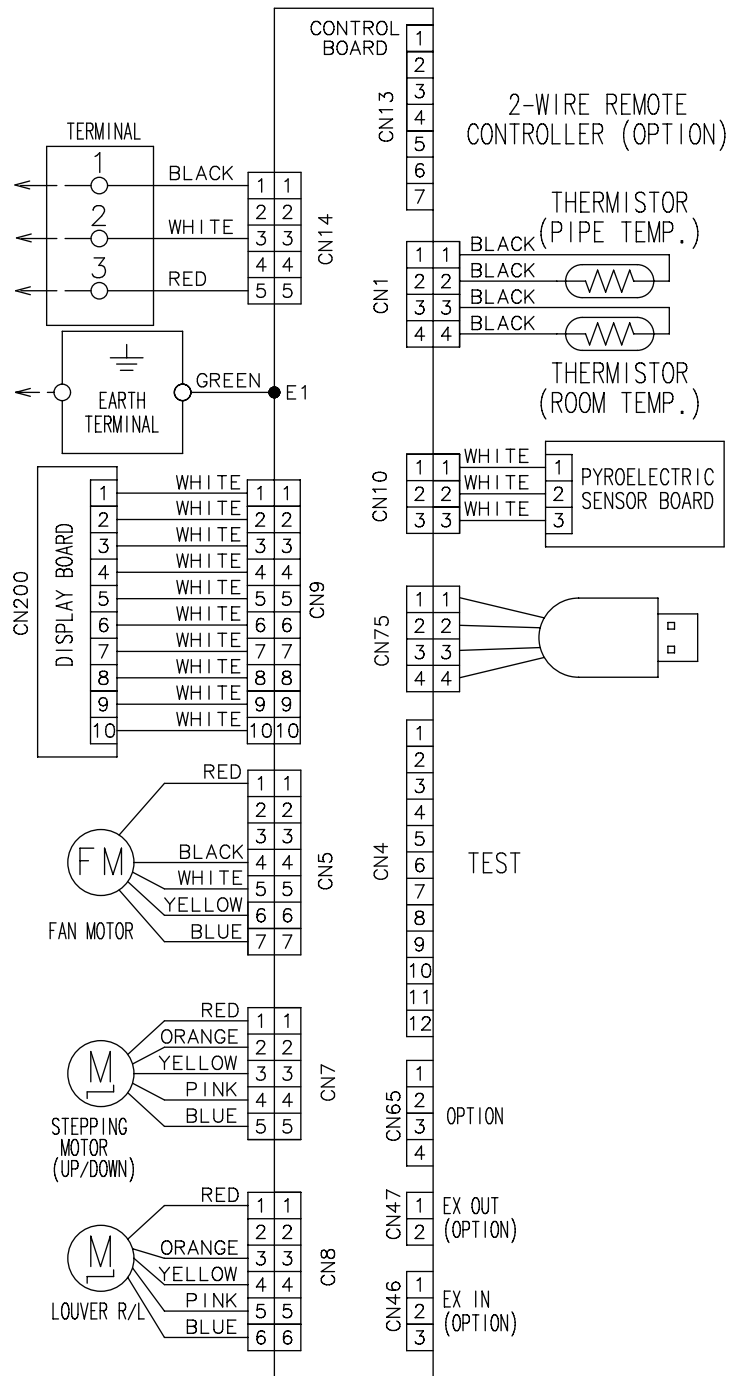

4. Capacity table

Capacity tables show each of following values calculated based on the outdoor temperature and the indoor temperature, under given Airflow Rate (AFR):

For cooling capacity: Total Capacity (TC), Sensible Heat Capacity (SHC), and Input Power (IP)

For heating capacity: Total Capacity (TC) and Input Power (IP)

4-1. Cooling capacity

■ Model: ASYH30KMTB

AFR		m ³ /h																		1,330		
Outdoor temperature	Indoor temperature																					
	°CDB	18			21			23			25			27			29			32		
	°CWB	12			15			16			18			19			21			23		
	°CDB	TC	SHC	IP	TC	SHC	IP	TC	SHC	IP	TC	SHC	IP	TC	SHC	IP	TC	SHC	IP	TC	SHC	IP
		kW			kW			kW			kW			kW			kW			kW		
-15	6.80	5.20	2.05	7.45	5.69	2.07	7.67	5.87	2.09	8.16	6.24	2.11	8.41	6.43	2.13	8.96	6.85	2.15	9.56	7.30	2.17	
-10	6.44	5.05	2.18	7.05	5.53	2.21	7.27	5.70	2.23	7.73	6.06	2.25	7.97	6.24	2.27	8.49	6.65	2.30	9.05	7.09	2.32	
0	6.58	5.16	2.03	7.20	5.65	2.05	7.42	5.82	2.07	7.89	6.19	2.09	8.13	6.38	2.11	8.66	6.80	2.13	9.23	7.25	2.15	
5	6.86	5.22	1.87	7.50	5.72	1.89	7.73	5.89	1.91	8.22	6.26	1.93	8.47	6.46	1.95	9.03	6.88	1.97	9.63	7.33	1.99	
10	7.14	5.38	1.72	7.81	5.89	1.74	8.05	6.07	1.76	8.56	6.45	1.77	8.83	6.65	1.79	9.41	7.09	1.81	10.03	7.56	1.83	
15	6.94	5.30	1.75	7.59	5.80	1.77	7.82	5.98	1.79	8.32	6.36	1.81	8.58	6.55	1.83	9.14	6.98	1.84	9.74	7.44	1.86	
20	6.97	5.27	1.79	7.63	5.77	1.81	7.86	5.94	1.82	8.36	6.32	1.84	8.62	6.51	1.86	9.18	6.94	1.88	9.79	7.40	1.90	
25	6.80	5.20	1.94	7.44	5.69	1.96	7.67	5.86	1.98	8.16	6.24	2.00	8.41	6.43	2.02	8.96	6.85	2.04	9.55	7.30	2.06	
30	6.64	5.13	2.09	7.26	5.61	2.11	7.48	5.79	2.13	7.96	6.15	2.15	8.20	6.34	2.17	8.74	6.76	2.20	9.32	7.20	2.22	
35	6.47	4.98	2.24	7.08	5.44	2.26	7.30	5.61	2.28	7.76	5.97	2.31	8.00	6.15	2.33	8.52	6.55	2.35	9.09	6.99	2.38	
40	6.39	5.02	2.48	6.99	5.50	2.51	7.20	5.66	2.53	7.66	6.02	2.56	7.89	6.21	2.59	8.41	6.62	2.61	8.97	7.05	2.64	
46	5.45	4.67	2.69	5.96	5.11	2.72	6.14	5.27	2.75	6.53	5.60	2.77	6.73	5.78	2.80	7.17	6.15	2.83	7.65	6.56	2.86	

■ Model: ASYH36KMTB

AFR		m ³ /h																		1,330		
Outdoor temperature	Indoor temperature																					
	°CDB	18			21			23			25			27			29			32		
	°CWB	12			15			16			18			19			21			23		
	°CDB	TC	SHC	IP	TC	SHC	IP	TC	SHC	IP	TC	SHC	IP	TC	SHC	IP	TC	SHC	IP	TC	SHC	IP
		kW			kW			kW			kW			kW			kW			kW		
-15	6.80	5.20	2.05	7.45	5.69	2.07	7.67	5.87	2.09	8.16	6.24	2.11	8.41	6.43	2.13	8.96	6.85	2.15	9.56	7.30	2.17	
-10	6.44	5.05	2.18	7.05	5.53	2.21	7.27	5.70	2.23	7.73	6.06	2.25	7.97	6.24	2.27	8.49	6.65	2.30	9.05	7.09	2.32	
0	6.58	5.16	2.03	7.20	5.65	2.05	7.42	5.82	2.07	7.89	6.19	2.09	8.13	6.38	2.11	8.66	6.80	2.13	9.23	7.25	2.15	
5	6.86	5.22	1.87	7.50	5.72	1.89	7.73	5.89	1.91	8.22	6.26	1.93	8.47	6.46	1.95	9.03	6.88	1.97	9.63	7.33	1.99	
10	7.14	5.38	1.72	7.81	5.89	1.74	8.05	6.07	1.76	8.56	6.45	1.77	8.83	6.65	1.79	9.41	7.09	1.81	10.03	7.56	1.83	
15	6.94	5.30	1.75	7.59	5.80	1.77	7.82	5.98	1.79	8.32	6.36	1.81	8.58	6.55	1.83	9.14	6.98	1.84	9.74	7.44	1.86	
20	7.99	5.27	2.48	8.74	5.77	2.51	9.01	5.94	2.53	9.58	6.32	2.56	9.88	6.51	2.58	10.52	6.94	2.61	11.22	7.40	2.63	
25	7.86	5.64	2.66	8.60	6.17	2.69	8.86	6.36	2.72	9.43	6.77	2.75	9.72	6.98	2.78	10.36	7.43	2.80	11.04	7.92	2.83	
30	7.73	5.59	2.85	8.46	6.12	2.88	8.72	6.30	2.91	9.27	6.70	2.94	9.56	6.91	2.97	10.19	7.36	3.00	10.86	7.85	3.03	
35	7.60	5.44	3.03	8.32	5.95	3.07	8.57	6.14	3.10	9.12	6.53	3.13	9.40	6.73	3.16	10.02	7.17	3.19	10.68	7.64	3.22	
40	6.97	5.28	3.18	7.62	5.77	3.21	7.86	5.95	3.24	8.35	6.33	3.28	8.61	6.52	3.31	9.18	6.95	3.34	9.78	7.41	3.37	
46	5.40	4.67	3.18	5.91	5.11	3.21	6.09	5.26	3.24	6.48	5.60	3.28	6.68	5.77	3.31	7.11	6.15	3.34	7.58	6.55	3.38	

4-2. Heating capacity

NOTE: Values mentioned in the table are calculated based on the maximum capacity.

Model: ASYH30KMTB

AFR	m ³ /h	1,330
-----	-------------------	-------

		Indoor temperature										
		16		18		20		22		27		
		TC	IP	TC	IP	TC	IP	TC	IP	TC	IP	
Outdoor temperature	°CDB	°CWB	kW		kW		kW		kW		kW	
	-15	-16	7.91	3.28	7.71	3.35	7.50	3.42	7.29	3.49	6.77	3.63
	-10	-11	9.17	3.63	8.93	3.70	8.69	3.78	8.45	3.85	7.85	4.00
	-5	-7	10.34	3.89	10.07	3.97	9.80	4.05	9.53	4.13	8.85	4.30
	0	-2	11.40	4.02	11.10	4.10	10.80	4.19	10.50	4.27	9.76	4.44
	5	3	12.20	4.06	11.88	4.14	11.56	4.23	11.24	4.31	10.44	4.49
	7	6	12.45	4.06	12.13	4.14	11.80	4.23	11.47	4.31	10.66	4.48
	10	8	12.33	3.58	12.01	3.65	11.68	3.73	10.15	3.80	10.15	3.96
	15	10	11.75	3.16	11.44	3.22	11.13	3.29	10.15	3.35	10.06	3.49
	20	15	11.17	2.73	10.87	2.79	10.58	2.85	10.15	2.90	9.56	3.02
24	18	10.71	2.48	10.43	2.53	10.15	2.58	9.87	2.63	9.17	2.74	

Model: ASYH36KMTB

AFR	m ³ /h	1,330
-----	-------------------	-------

		Indoor temperature										
		16		18		20		22		27		
		TC	IP	TC	IP	TC	IP	TC	IP	TC	IP	
Outdoor temperature	°CDB	°CWB	kW		kW		kW		kW		kW	
	-15	-16	8.55	3.33	8.32	3.40	8.10	3.47	7.88	3.54	7.32	3.68
	-10	-11	9.87	3.71	9.61	3.78	9.35	3.86	9.09	3.93	8.45	4.09
	-5	-7	11.10	3.98	10.81	4.06	10.52	4.14	10.23	4.22	9.51	4.39
	0	-2	12.22	4.08	11.90	4.17	11.58	4.26	11.26	4.34	10.46	4.51
	5	3	13.04	4.13	12.70	4.21	12.36	4.30	12.02	4.38	11.17	4.56
	7	6	13.30	4.13	12.95	4.21	12.60	4.30	12.25	4.38	11.38	4.56
	10	8	13.17	3.64	12.82	3.72	12.48	3.79	10.84	3.87	10.84	4.02
	15	10	12.54	3.21	12.22	3.27	11.89	3.34	10.84	3.41	10.74	3.55
	20	15	11.92	2.78	11.61	2.83	11.30	2.89	10.84	2.95	10.21	3.07
24	18	11.44	2.52	11.14	2.57	10.84	2.63	10.54	2.68	9.79	2.78	

5. Fan performance

5-1. Air velocity distributions

■ Models: ASYH30KMTB and ASYH36KMTB

Measuring conditions	Fan speed	Operation mode
	HIGH	FAN

Top view
Horizontal louver: Up
Vertical louver: Center

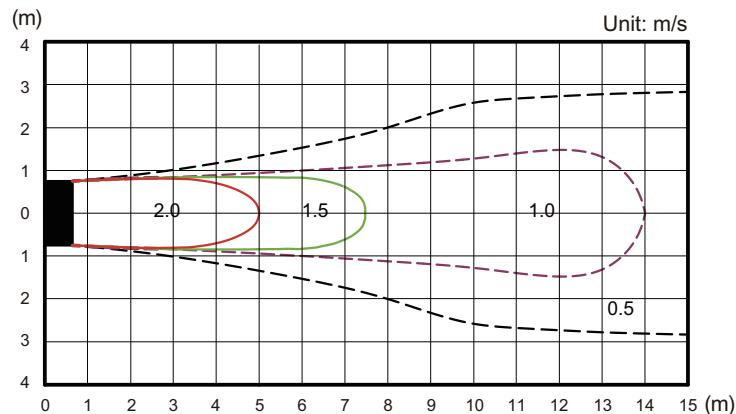

Top view
Horizontal louver: Up
Vertical louver: Left & Right

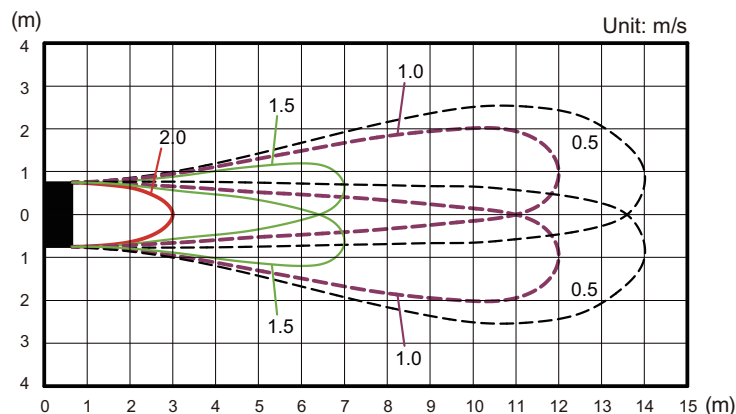

Side view
Horizontal louver: Up
Vertical louver: Center

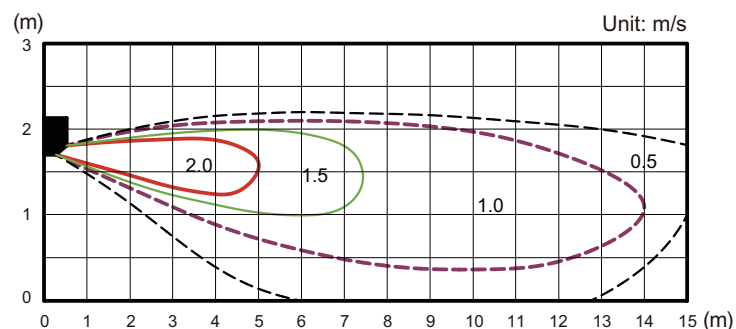

Side view
Horizontal louver: Down
Vertical louver: Center

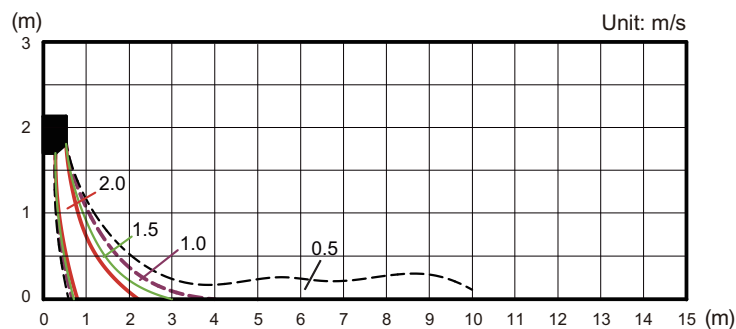

5-2. Airflow

■ Models: ASYH30KMTB and ASYH36KMTB

● Cooling

Fan speed	Airflow	
HIGH	m ³ /h	1,330
	l/s	369
	CFM	783
MED	m ³ /h	1,100
	l/s	306
	CFM	647
LOW	m ³ /h	920
	l/s	256
	CFM	542
QUIET	m ³ /h	720
	l/s	200
	CFM	424

● Heating

Fan speed	Airflow	
HIGH	m ³ /h	1,330
	l/s	369
	CFM	783
MED	m ³ /h	1,100
	l/s	306
	CFM	647
LOW	m ³ /h	920
	l/s	256
	CFM	542
QUIET	m ³ /h	720
	l/s	200
	CFM	424

6. Operation noise (sound pressure)

6-1. Noise level curve

Model: ASYH30KMTB

● Cooling

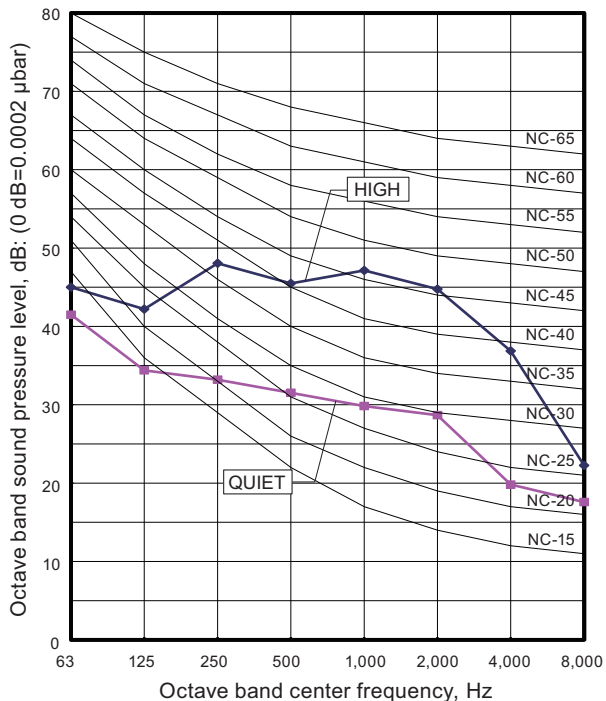

● Heating

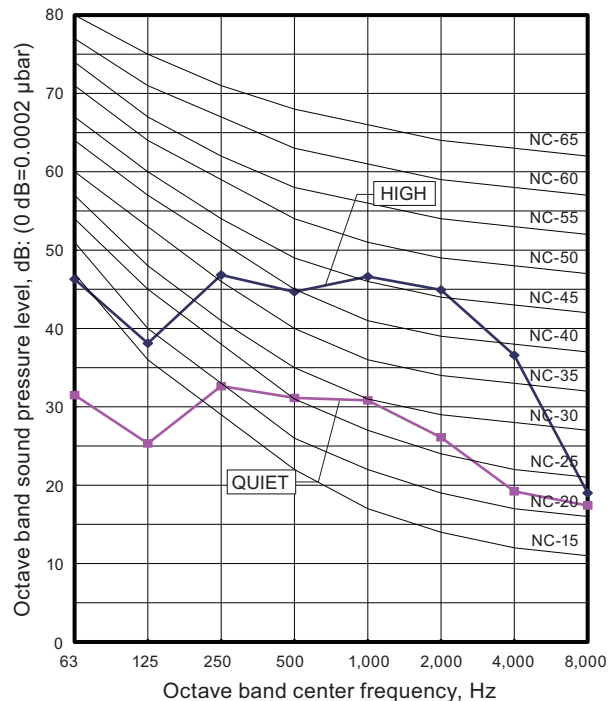

Model: ASYH36KMTB

● Cooling

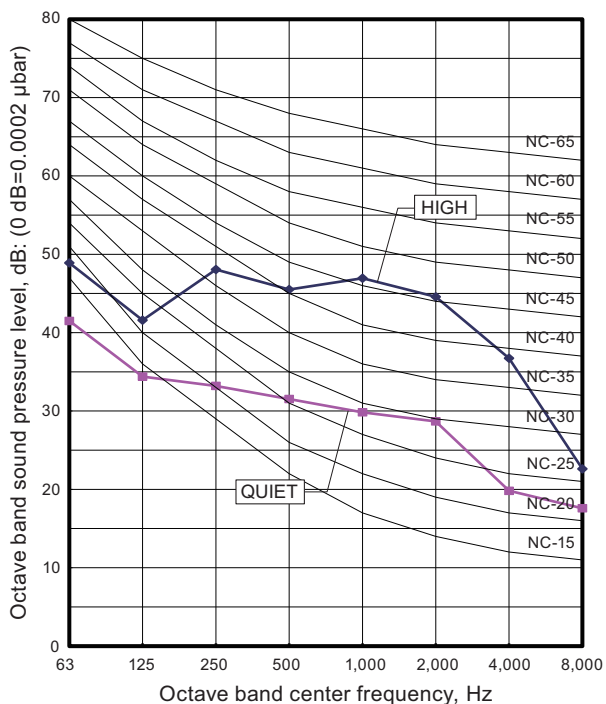

● Heating

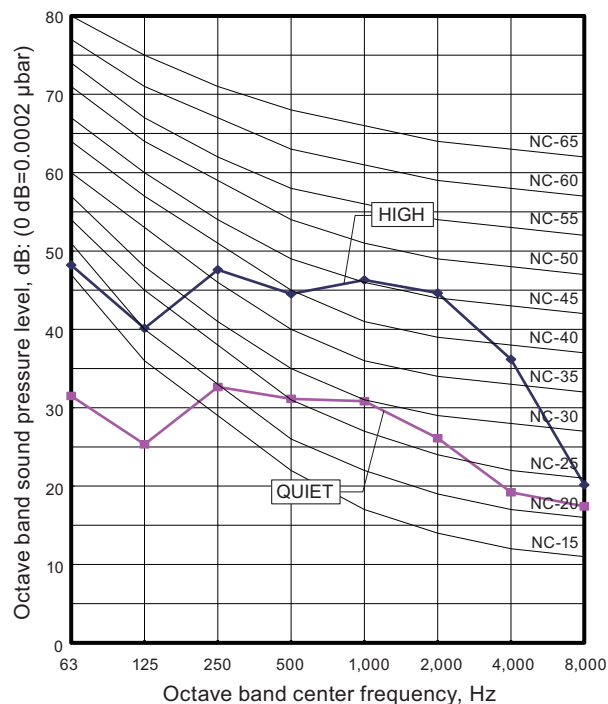

6-2. Sound level check point

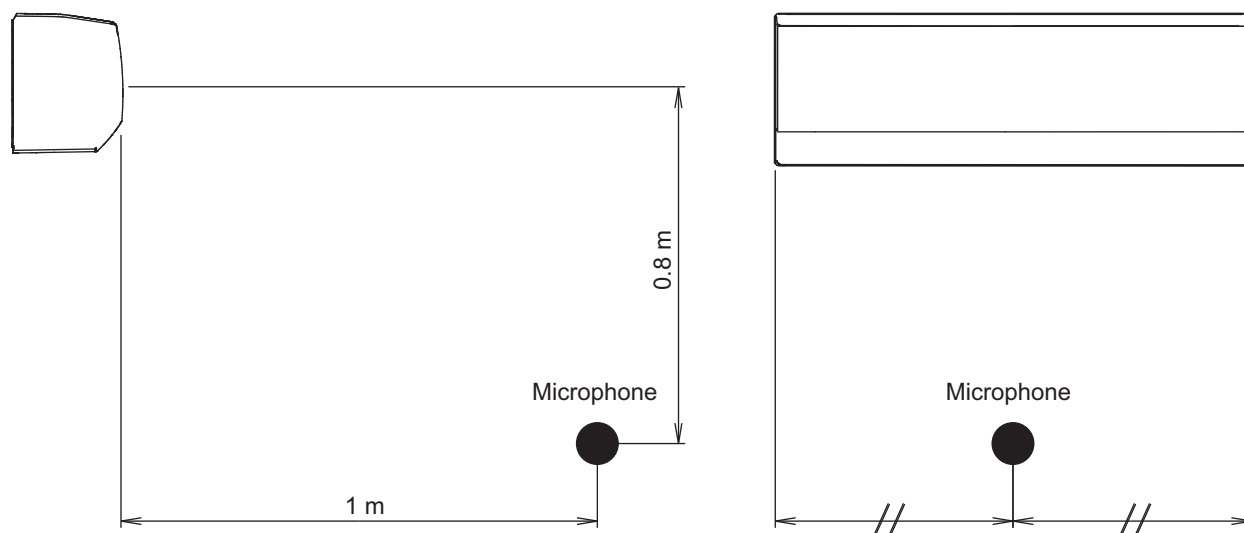

NOTE: Detailed shape of the actual indoor unit might be slightly different from the one illustrated above.

7. Safety devices

Type of protection	Protection form		Model	
			ASYH30KMTB	ASYH36KMTB
Circuit protection	Current fuse (PCB*)		250 V, 3.15 A	
Fan motor protection	Thermal protection	Activate	125±10°C Fan motor stop	
		Reset	100±10°C Fan motor restart	

*PCB: Printed Circuit Board

8. External input and output

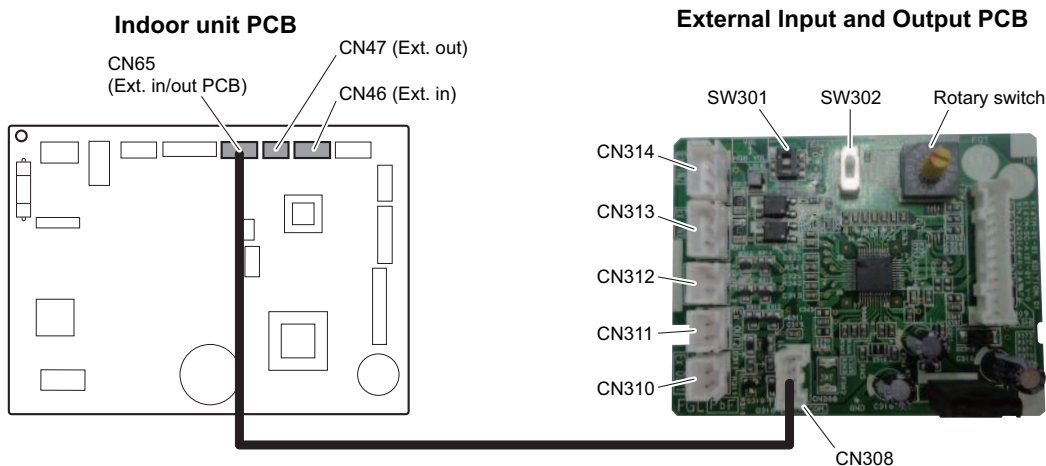

Connecting point		Input/Output	Function	Input select	Input signal
Indoor unit	CN46	Input	Operation/Stop	Dry contact	Edge
			Forced stop		
	CN47	Output	Operation/Stop	—	—
			Error status		
			Indoor unit fan operation status		
		Set point attainment status			
External Input and Output PCB (UTY-XCSXZ2)	CN313	Input	Operation/Stop	Dry contact/Apply voltage	Edge/Pulse
	CN314		Forced stop		
	CN313		Forced thermostat off		Edge
	CN310	Output	Operation/Stop	—	—
	CN311		Error status		
CN312	Indoor unit fan operation status				

NOTE: For details of the switching function, refer to "[Setting of external input and output](#)" on page 20.

8-1. External input

With using external input function, some functions on this product can be controlled from an external device.

- "Operation/Stop" mode or "Forced stop" mode can be selected with function setting of indoor unit.
- A twisted pair cable should be used. Maximum length of cable is 150 m.
- Use an external input and output cable with appropriate external dimension, depending on the number of cables to be installed.
- The wire connection should be separate from the power cable line.

■ Indoor unit

Indoor unit functions such as Operation/Stop can be done by using indoor unit connectors.

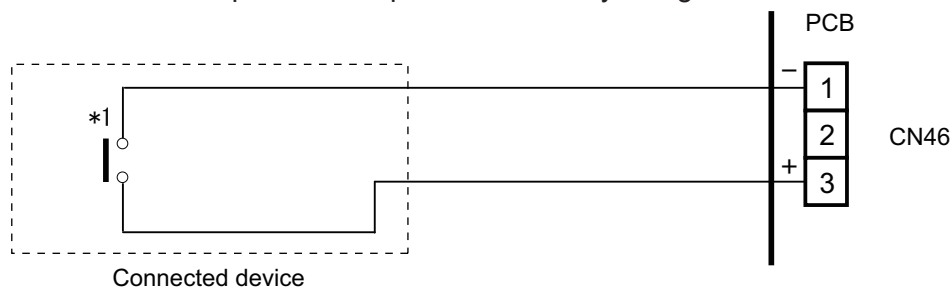

*1: The switch can be used on the following condition: DC 12 V to 24 V, 1 mA to 15 mA.

External Input and Output PCB

The indoor unit Operation/Stop can be set by using the input connector on the PCB.

Input select

Use either one of these types of connectors according to the application. (Both types of connectors cannot be used simultaneously.)

– Dry contact

In case of internal power supply, set the slide switch of SW301 to "NON VOL" side.

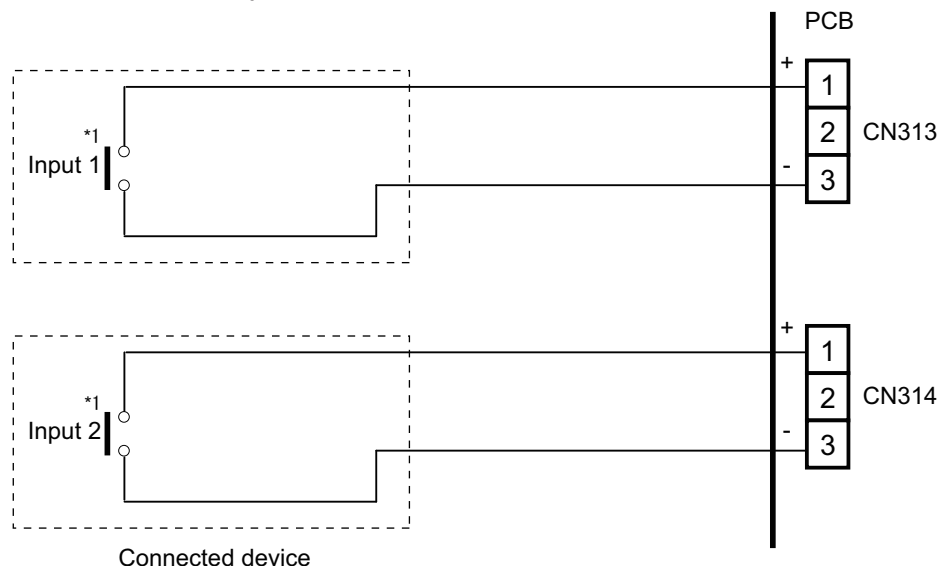

*1: The switches can be used on the following condition: DC 12 V to 24 V, 1 mA to 15 mA.

– Apply voltage

In case of external power supply, set the slide switch of SW301 to "VOL" side.

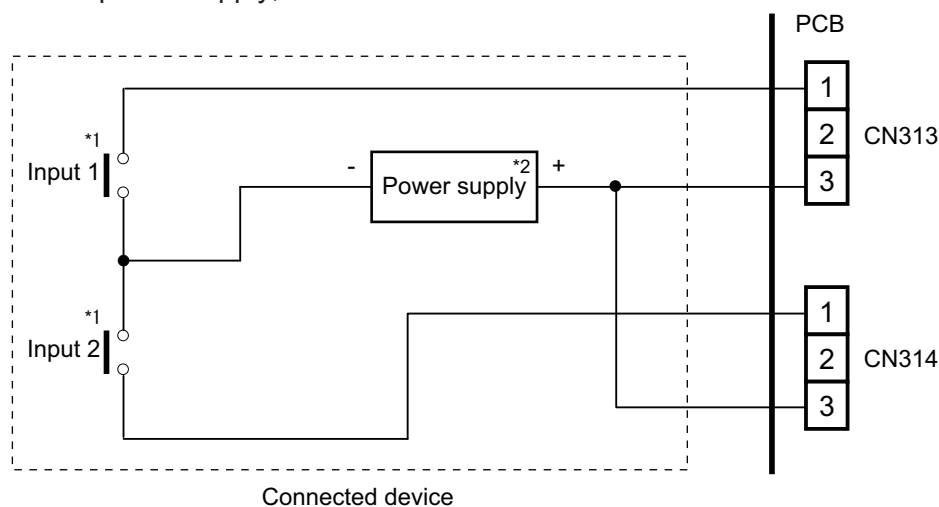

*1: The switches can be used on the following condition: DC 12 V to 24 V, 1 mA to 15 mA.

*2: Make the power supply DC 12 V to 24 V, 10 mA or more.

Input signal type

- **Indoor unit**

Input signal type is only "Edge".

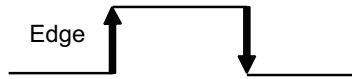

- **External Input and Output PCB**

The input signal type can be selected.

Signal type (edge or pulse) can be switched by the DIP switch 2 (SW302) on the External Input and Output PCB.

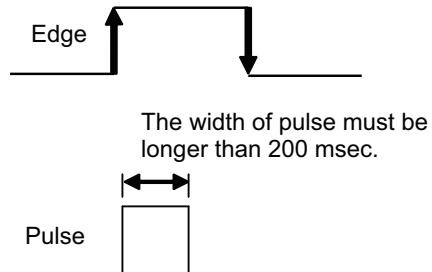

NOTE: The input signal supports the following switch type:

- Edge: Alternate type switch
- Pulse: Momentary type switch

8-2. External output

Use an external output cable with appropriate external dimension, depending on the number of cables to be installed.

Indoor unit

- A twisted pair cable should be used. Maximum length of cable is 25 m.
- Output voltage: High DC 12 V \pm 2 V, Low 0 V.
- Permissible current: 50 mA
- For details, refer to ["Setting of external input and output"](#) on page 20.

- **When indicator, etc. are connected directly**

Example: Function setting number 60 is set to "00"

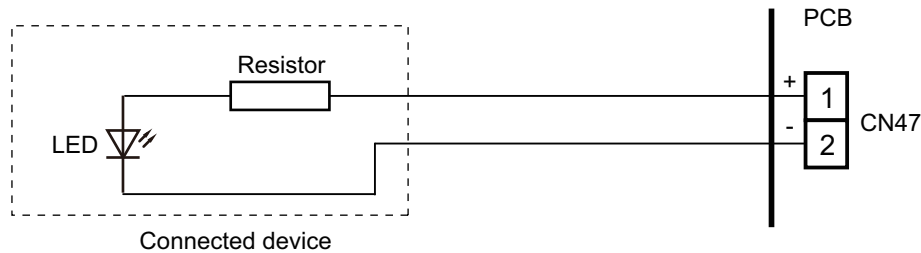

- **When connecting with a device equipped with a power supply**

Example: Function setting number 60 is set to "00"

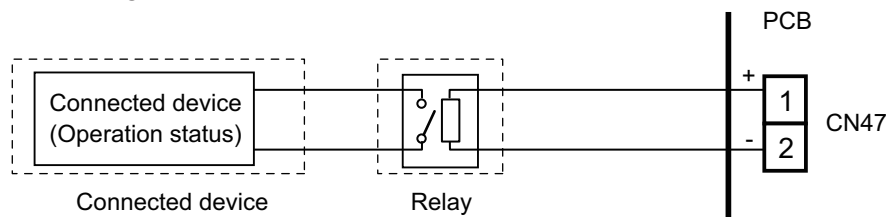

External Input and Output PCB

- A twisted pair cable should be used. Maximum length of cable is 25 m.
 - Output voltage: High DC 12 V \pm 2 V, Low 0 V.
 - Permissible current: 50 mA
 - For details, refer to "[Setting of external input and output](#)" on page 20.
- **When indicator or other components are connected directly:**
Example: Rotary SW on External Input and Output PCB is set to "1".

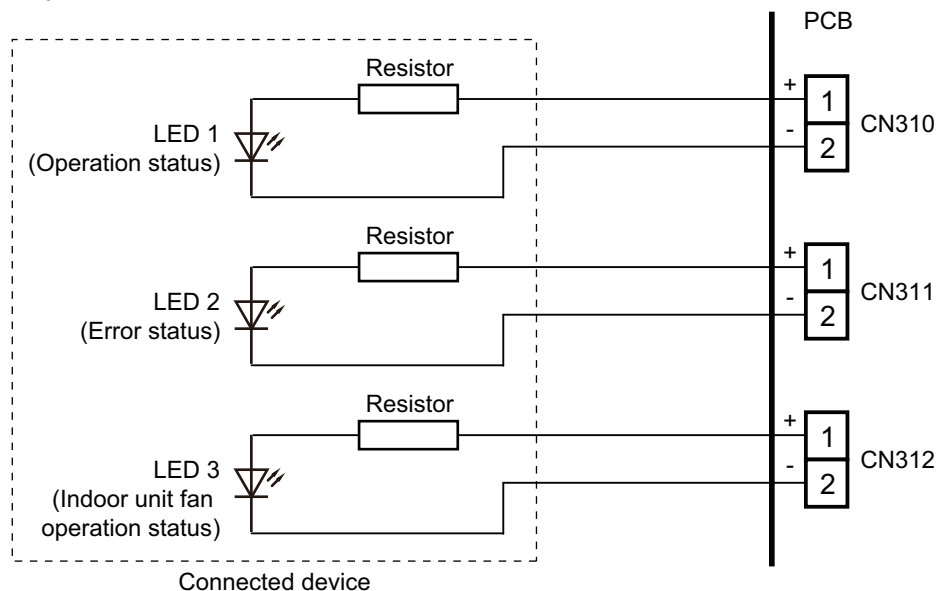

- **When connecting with a device equipped with a power supply:**
Example: Rotary SW on External Input and Output PCB is set to "1".

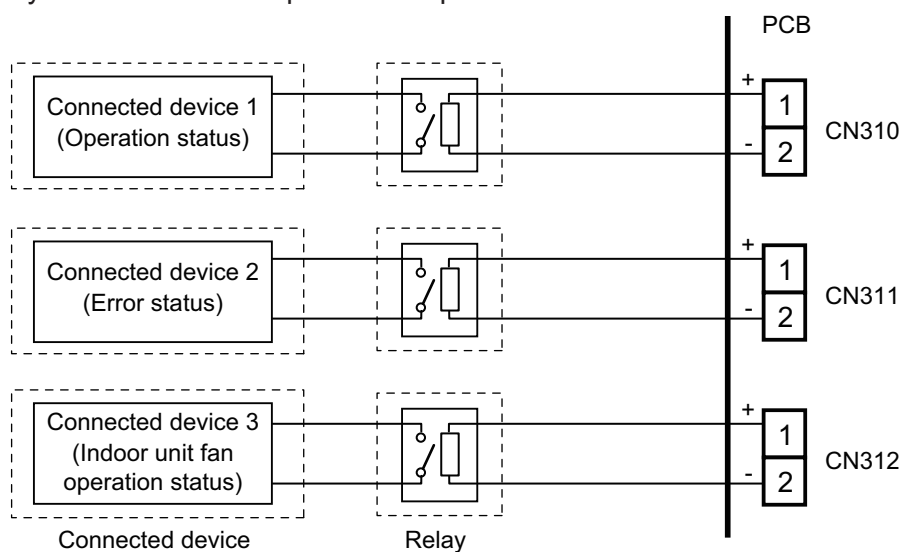

8-3. Setting of external input and output

- Indoor unit

Input		
Connection point	Function setting number 46	Function
CN46	00	Operation/Stop mode 1 (R.C. enabled)
	01	(Setting prohibited)
	02	Forced stop mode
	03	Operation/Stop mode 2 (R.C. disabled)

Output		
Connection point	Function setting number 60	Function
CN47	00	Operation/Stop
	01 to 08	(Setting prohibited)
	09	Error status
	10	Indoor unit fan operation status
	11	(Setting prohibited)
	12	Setpoint attainment status

- External Input and Output PCB

Switch setting		Input		Output		
Rotary switch	SW302	CN313	CN314	CN310	CN311	CN312
1	Edge	Operation/Stop	Not available	Operation/Stop	Error status	Indoor unit fan operation status
	Pulse	Operation	Stop			
2	Edge*	Forced thermostat off	Not available	Error status	Indoor unit fan operation status	Not available
3 to 9, A		(Setting prohibited)				
B		Forced thermostat off	Not available	Operation/Stop	Indoor unit fan operation status	Not available
C		Forced thermostat off	Not available	Operation/Stop	Error status	Not available
D		Forced thermostat off	Not available	Operation/Stop	Indoor unit fan operation status	Error status

NOTES:

- When the rotary switch is selected to "1", the operation of the connector input of the indoor unit and the External Input and Output PCB input are the same. The operation content depends on the setting of function setting number 46.
- *: The external input other than "Operation/Stop" is available only when the SW302 is set to "Edge".

8-4. Details of control input function

■ Operation/Stop mode 1

- In the case of "Edge" input

Function setting	External Input and Output PCB		External input		Input signal	Command
	Rotary switch	SW302				
46-00	—		Input of indoor unit	CN46	Off → On	Operation
	—				On → Off	Stop
	1	Edge	External Input and Output PCB	CN313	Off → On	Operation
					On → Off	Stop

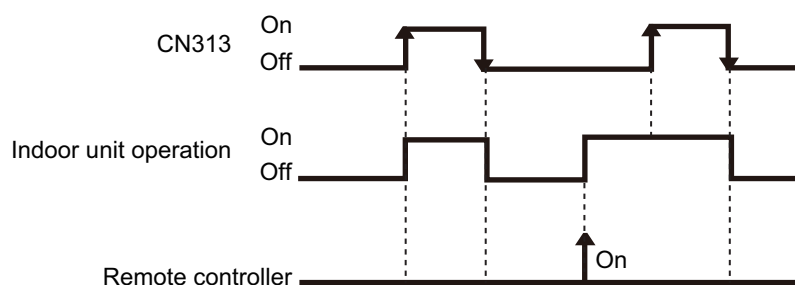

- In the case of "Pulse" input

Function setting	External Input and Output PCB		External input		Input signal	Command
	Rotary switch	SW302				
46-00	1	Pulse	External Input and Output PCB	CN313	Pulse	Operation
				CN314		Stop

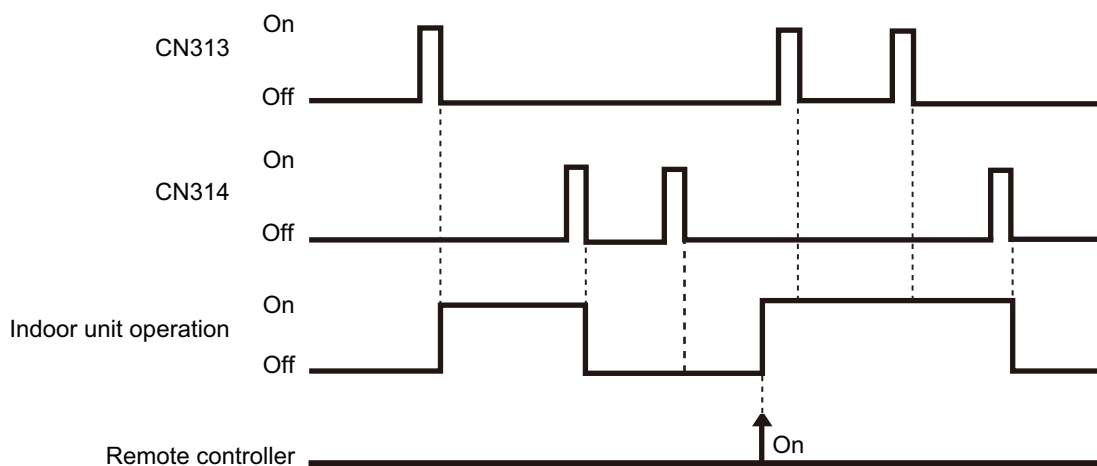

NOTES:

- The last command has priority.
- The indoor units within the same remote controller group operates in the same mode.

■ Forced stop

- In the case of "Edge" input

Function setting	External Input and Output PCB		External input		Input signal	Command
	Rotary switch	SW302				
46-02	—		Input of indoor unit	CN46	Off → On	Forced stop (R.C. disabled)
					On → Off	Normal (R.C. enabled)
	1	Edge	External Input and Output PCB	CN313	Off → On	Forced stop (R.C. disabled)
					On → Off	Normal (R.C. enabled)

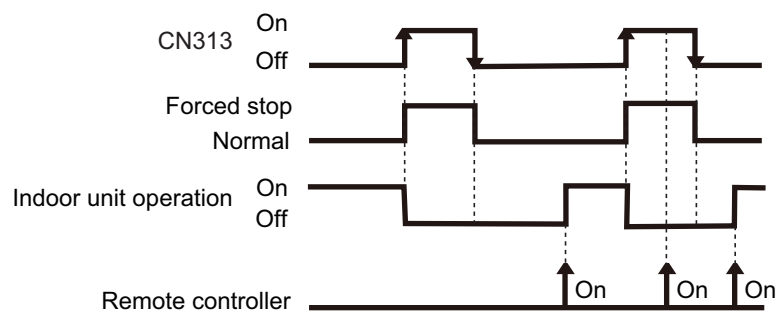

- In the case of "Pulse" input

Function setting	External Input and Output PCB		External input		Input signal	Command
	Rotary switch	SW302				
46-02	1	Pulse	External Input and Output PCB	CN313	Pulse	Forced stop (R.C. disabled)
				CN314		Normal (R.C. enabled)

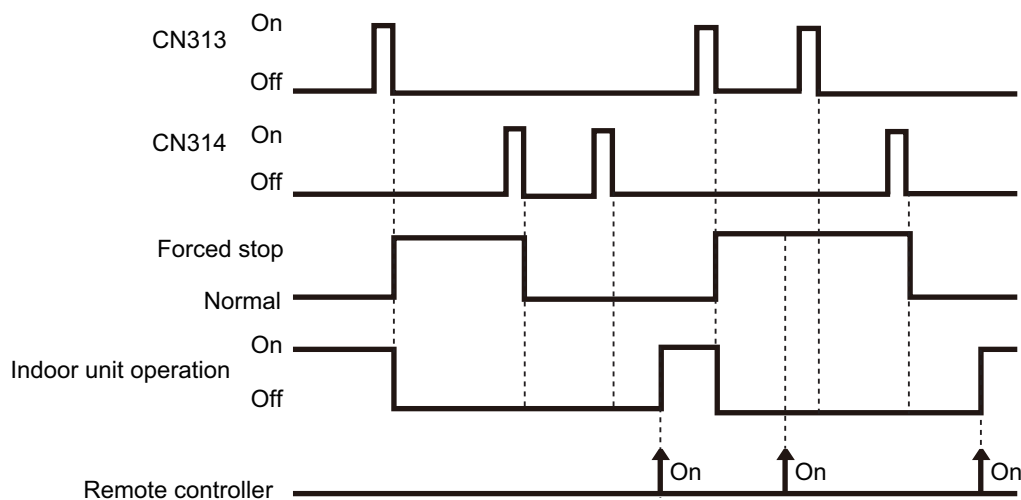

NOTES:

- When the forced stop is triggered, indoor unit stops and Operation/Stop operation by the remote controller is restricted.
- When forced stop function is used with forming a remote controller group, connect the same equipment to each indoor unit within the group.

■ Operation/Stop mode 2

- In the case of “Edge” input

Function setting	External Input and Output PCB		External input		Input signal	Command
	Rotary switch	SW302				
46-03	—		Input of indoor unit	CN46	Off → On	Operation (R.C. enabled)
					On → Off	Stop (R.C. disabled)
	1	Edge	External Input and Output PCB	CN313	Off → On	Operation (R.C. enabled)
					On → Off	Stop (R.C. disabled)

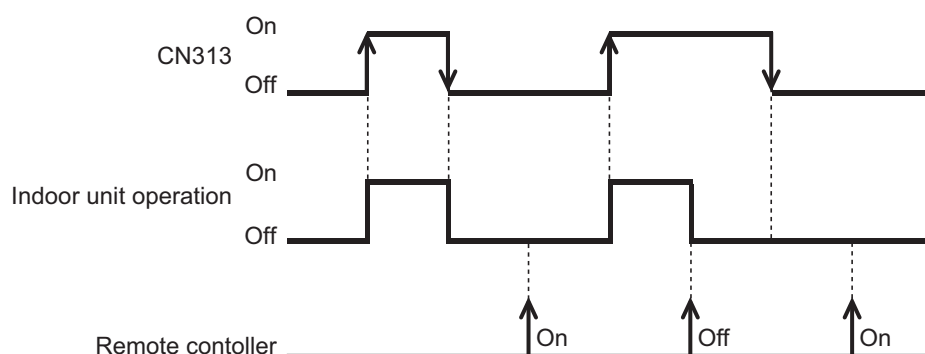

- In the case of “Pulse” input

Function setting	External Input and Output PCB		External input		Input signal	Command
	Rotary switch	SW302				
46-03	1	Pulse	External Input and Output PCB	CN313	Pulse	Operation (R.C. enabled)
				CN314		Stop (R.C. disabled)

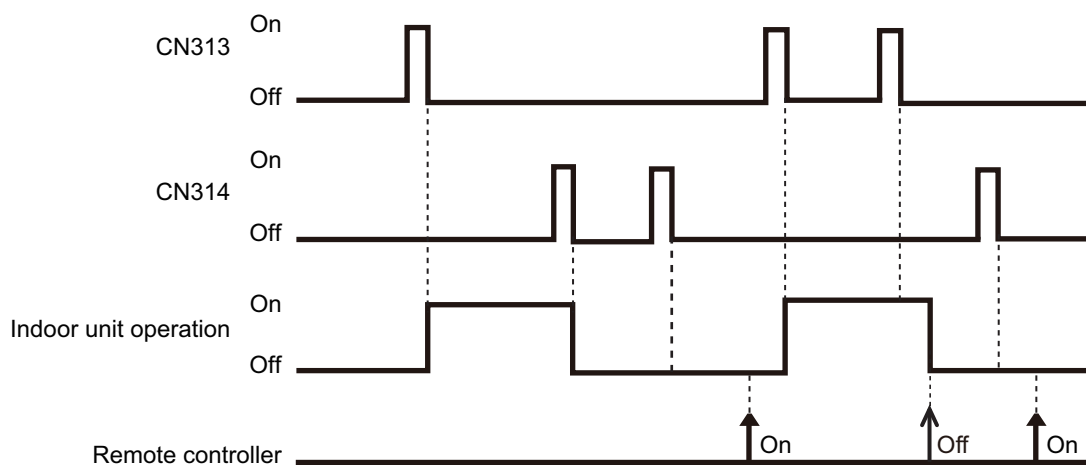

NOTE: When “Operation/Stop” mode 2 function is used with forming a remote controller group, connect the same equipment to each indoor unit within the group.

■ Forced thermostat off

External Input and Output PCB	External input		Input signal	Command
Rotary switch				
2, B, C, D	External Input and Output PCB	CN313	Off → On	Thermostat off
			On → Off	Normal operation

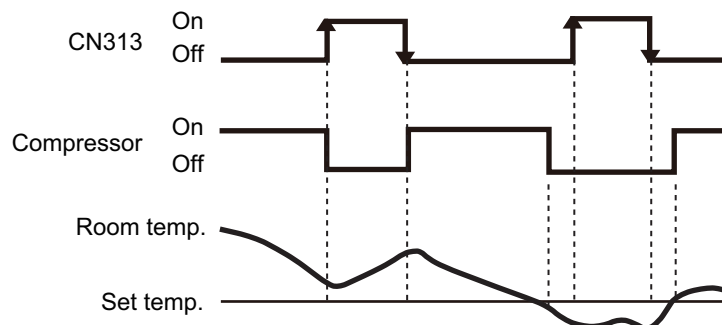

8-5. Details of control output function

■ Operation status

Function setting	External Input and Output PCB	External output		Output signal	Status
	Rotary switch				
60-00	1, 2	Output of indoor unit	CN47	Off → On	Operation
				On → Off	Stop
—	1, B, C, D	External Input and Output PCB	CN310	Off → On	Operation
				On → Off	Stop

The output is low when the unit is stopped.

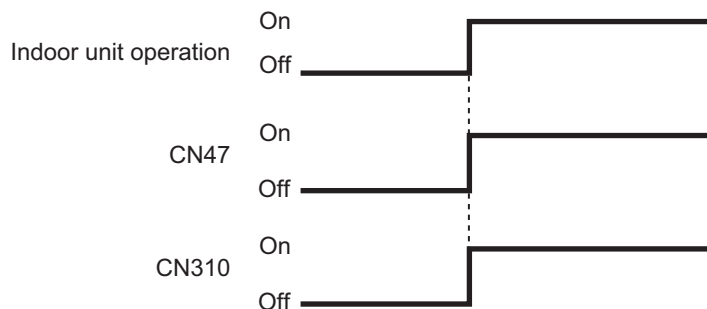

■ Error status

Function setting	External Input and Output PCB	External output		Output signal	Status
	Rotary switch				
60-09	—	Output of indoor unit	CN47	Off → On	Error
				On → Off	Normal
—	2	External Input and Output PCB	CN310	Off → On	Error
				On → Off	Normal
—	1, C	External Input and Output PCB	CN311	Off → On	Error
				On → Off	Normal
—	D	External Input and Output PCB	CN312	Off → On	Error
				On → Off	Normal

The output is on when an error is generated for the indoor unit.

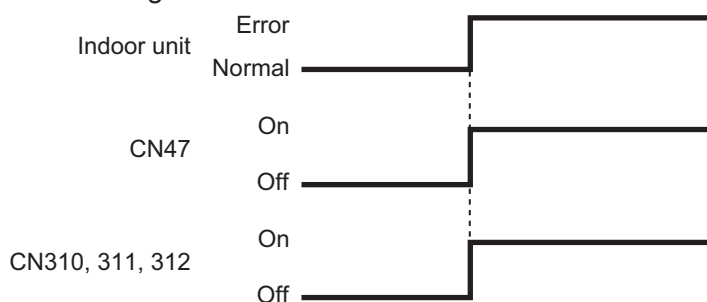

Indoor unit fan operation status

Function setting	External Input and Output PCB	External output		Output signal	Status
	Rotary switch				
60-10	C	Output of indoor unit	CN47	Off → On	Fan run
				On → Off	Fan stop
—	2, B, D	External Input and Output PCB	CN311	Off → On	Fan run
				On → Off	Fan stop
—	1	External Input and Output PCB	CN312	Off → On	Fan run
				On → Off	Fan stop

Output signal	Condition
On	The indoor unit fan is operating.
Off	The fan is stopped or during cold air prevention. During thermostat off when in dry mode operation.

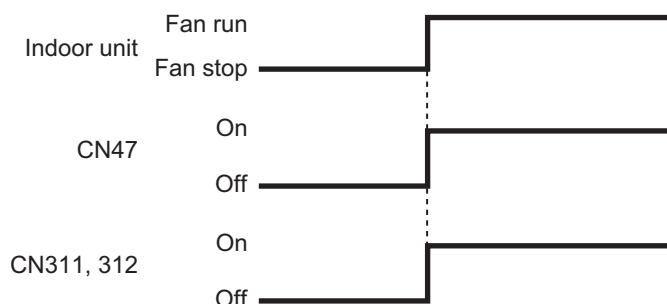

Setpoint attainment status

NOTE: This function is valid only when function setting 96 is “Enable” (01).

When the room temperature does not reach the setpoint at a room due to the lower cooling performance caused by external factor such as the outdoor temperature change, signal is output to tell the attainment status of setpoint.

Function setting	External Input and Output PCB	External output		Output signal	Command
	Rotary switch				
60-12	D	Output of indoor unit	CN47	On → Off	Normal
				Off → On	Setpoint attainment

Output signal	Condition
Off	Reached the setpoint. ($Tr \leq Tsa + 0.5^{\circ}C$)
On	Unreached the setpoint. ($Tr > Tsa + 2.5^{\circ}C$) However, even if the setpoint unreached, the signal will not be output for 7 minutes after power is turned on.

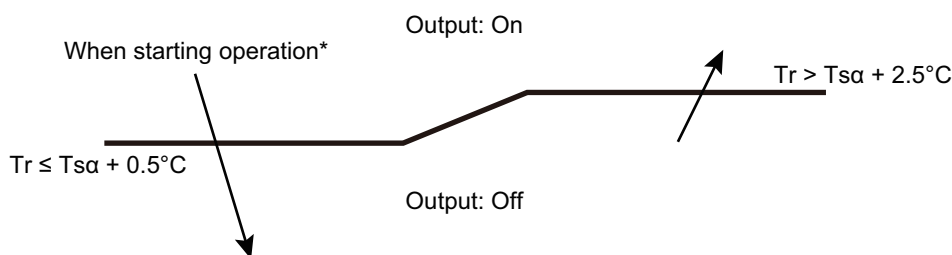

*: When starting operation or resetting, judges the zone to descending direction.

9. Group connection

NOTE: Group control cannot be used together with WLAN Adapter.

Installation procedure for group control system:

A number of indoor units can be operated at the same time using a single remote controller.

NOTE: When different type of indoor units (such as wall mounted type and cassette type, cassette type and duct type, or other combinations) are connected using group control system, some functions may no longer be available.

1. Connect up to 16 indoor units in a system.

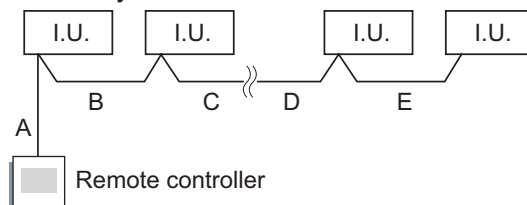

A, B, C, D, E: Remote controller cable	
Wiring length limitation	$A + B + C + D + E \leq 500 \text{ m}$

Example of wiring method

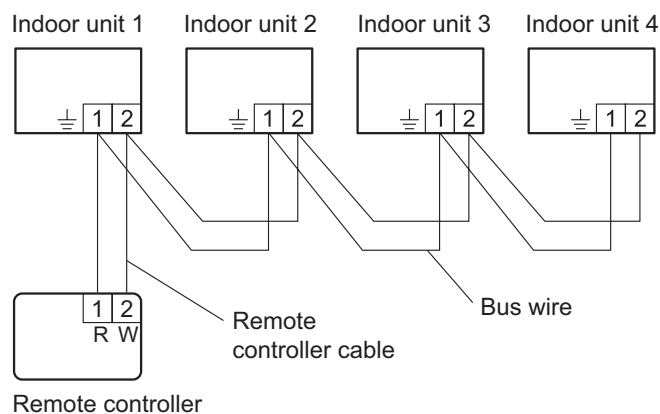

10. Remote controller

10-1. Wireless remote controller

Overview

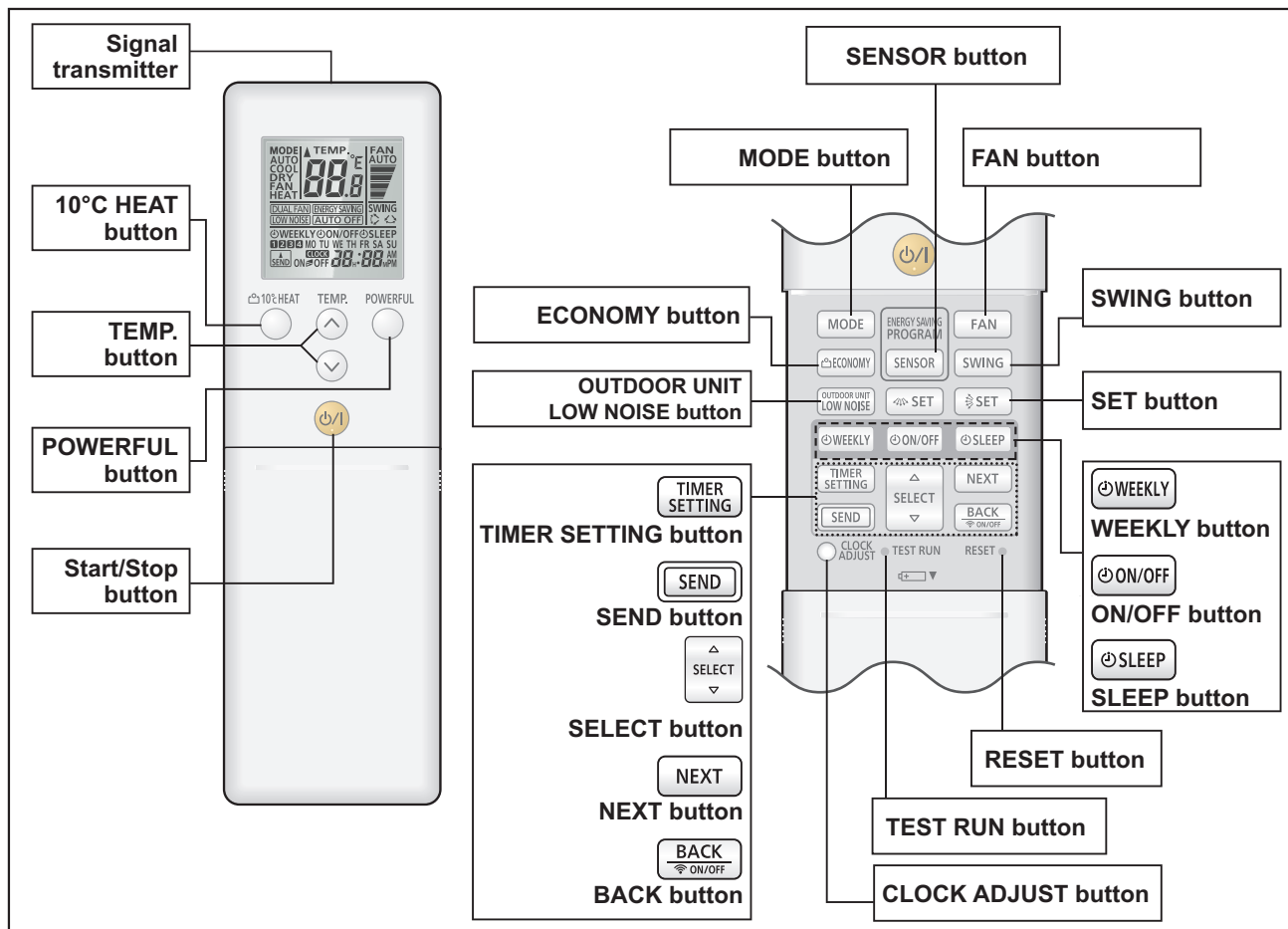

NOTE: Functions may differ by type of the indoor unit. For details, refer to the operation manual.

Display panel

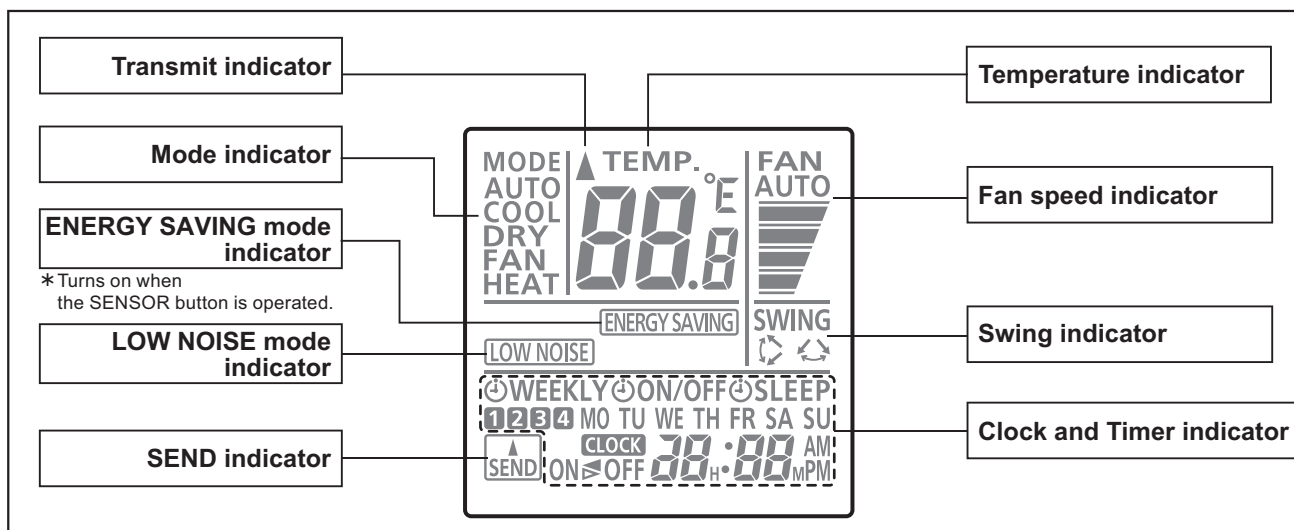

To facilitate explanation, the accompanying illustration has been drawn to show all possible indicators; in actual operation, however, the display will only show those indicators appropriate to the current operation.

Specifications

● Controller

Unit: mm

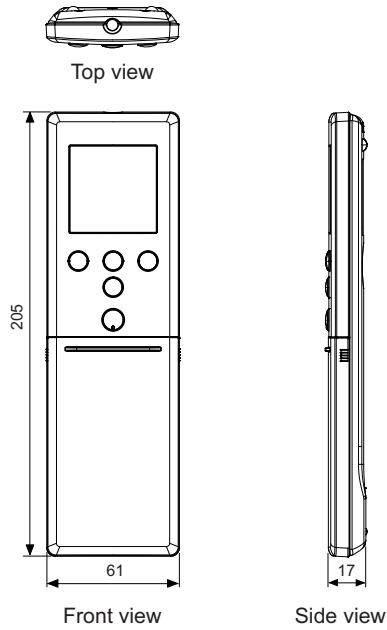

Size (H × W × D)	mm	205 × 61 × 17
Weight	g	124 (without batteries)

● Holder

Unit: mm

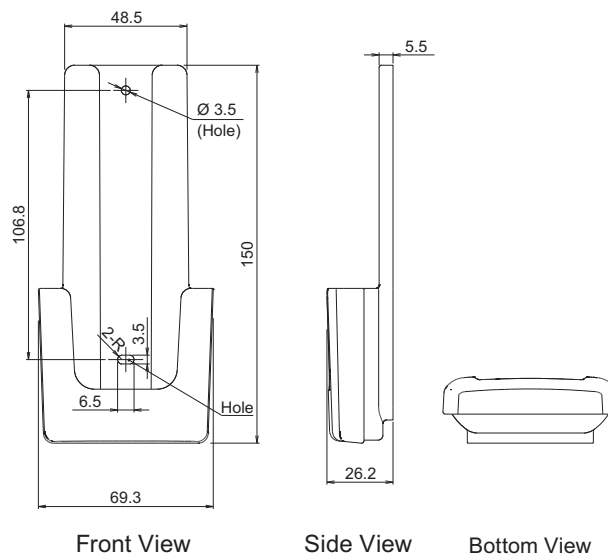

Size (H × W × D)	mm	150 × 69.3 × 26.2
Weight	g	27

11. Function settings

To adjust the functions of this product according to the installation environment, various types of function settings are available.

NOTE: Incorrect settings can cause a product malfunction.

11-1. Function settings by using remote controller

Some function settings can be changed on the remote controller. After confirming the setting procedure and the content of each function setting, select appropriate functions for your installation environment.

■ Setting procedure by using wireless remote controller

The function number and the associated setting value are displayed on the LCD of the remote controller. Follow the instructions written in the local setup procedure supplied with the remote controller, and select appropriate setting according to the installation environment.

Before connecting the power supply of the indoor unit, reconfirm following items:

- Cover for the electrical enclosure on the outdoor unit is in place.
- There is no wiring mistake.
- Piping air tightness test and vacuuming have been performed firmly.
- All the necessary wiring work for outdoor unit has been finished.

After reconfirming the items listed above, connect the power supply of the indoor unit.

NOTES:

- Settings will not be changed if invalid numbers or setting values are selected.
- When optional wired remote controller is used, refer to the installation manual enclosed with the remote controller.

Entering function setting mode:

While pressing the POWERFUL button and TEMP. (^) button simultaneously, press the RESET button to enter the function setting mode.

Selecting the function number and setting value:

1. Press the TEMP. (^) (v) buttons to select the function number. To switch between the left and right digits, press the 10 °C HEAT button.
2. Press the POWERFUL button to proceed to value setting. To return the function number selection, press the POWERFUL button again.
3. Press the TEMP. (^) (v) buttons to select the setting value. To switch between the left and right digits, press the 10 °C HEAT button.
4. Press the MODE button once. Confirm that you hear the beep sound.
5. Press the START/STOP button to fix the function setting. Confirm that you hear the beep sound.
6. Press the RESET button to end the function setting mode.
7. After completing the function setting, be sure to disconnect the power supply and then reconnect it.

Function number
Setting value



⚠ CAUTION

After disconnecting the power supply, wait 30 seconds or more before reconnecting it. The function setting will not become active unless the power supply is disconnected and then reconnected.

NOTES:

- The air conditioner custom code is set to \overline{H} prior to shipment.
- If you do not know the air conditioner custom code setting, try each of the custom codes ($\overline{H} \rightarrow \overline{b}$
 $\rightarrow \overline{c} \rightarrow \overline{d}$) until you find the code that operates the air conditioner.

■ Contents of function setting

Each function setting listed in this section is adjustable in accordance with the installation environment.

NOTE: Setting will not be changed if invalid numbers or setting values are selected.

● Function setting list

	Function no.	Functions
1)	11	Filter sign
2)	30/31	Room temperature control for indoor unit sensor
3)	35/36	Room temperature control for wired remote controller sensor
4)	40	Auto restart
5)	42	Room temperature sensor switching
6)	44	Remote controller custom code
7)	46	External input control
8)	48	Room temperature sensor switching (Aux.)
9)	49	Indoor unit fan control for energy saving for cooling
10)	60	Switching functions for external output terminal
11)	96	Special cooling operation

1) Filter sign

Select appropriate intervals for displaying the filter sign on the indoor unit according to the estimated amount of dust in the air of the room.

If the indication is not required, select "No indication" (03).

Function number	Setting value	Setting description	Factory setting
11	00	Standard (400 hours)	
	01	Long interval (1,000 hours)	
	02	Short interval (200 hours)	
	03	No indication	◆

2) Room temperature control for indoor unit sensor

Depending on the installed environment, correction of the room temperature sensor may be required. Select the appropriate control setting according to the installed environment.

The temperature of the room temperature sensor is corrected as follows:

Corrected temp. = Temp. of the room temp. sensor - Correction temp. value

Example of correction:

When the temperature of the room temp. sensor is 26°C and the setting value is "03" (-1.0°C), corrected temp. will be 27°C (26°C - [-1.0°C]).

The temperature correction values show the difference from the Standard setting "00" (manufacturer's recommended value).

Function number		Setting value	Setting description	Factory setting	
30 (For cooling)	31 (For heating)	00	Standard setting	◆	
		01	No correction 0.0 °C		
		02	-0.5 °C	More cooling Less heating	
		03	-1.0 °C		
		04	-1.5 °C		
		05	-2.0 °C		
		06	-2.5 °C		
		07	-3.0 °C		
		08	-3.5 °C		
		09	-4.0 °C		
		10	+0.5 °C	Less cooling More heating	
		11	+1.0 °C		
		12	+1.5 °C		
		13	+2.0 °C		
		14	+2.5 °C		
		15	+3.0 °C		
		16	+3.5 °C		
17	+4.0 °C				

3) Room temperature control for wired remote controller sensor

Depending on the installed environment, correction of the wire remote temperature sensor may be required. Select the appropriate control setting according to the installed environment.

To change this setting, set Function 42 to Both "01".

Ensure that the Thermo Sensor icon is displayed on the remote controller screen.

Function number		Setting value	Setting description	Factory setting	
35 (For cooling)	36 (For heating)	00	Standard setting	◆	
		01	No correction 0.0°C		
		02	-0.5 °C	More cooling Less heating	
		03	-1.0 °C		
		04	-1.5 °C		
		05	-2.0 °C		
		06	-2.5 °C		
		07	-3.0 °C		
		08	-3.5 °C		
		09	-4.0 °C		
		10	+0.5 °C	Less cooling More heating	
		11	+1.0 °C		
		12	+1.5 °C		
		13	+2.0 °C		
		14	+2.5 °C		
		15	+3.0 °C		
		16	+3.5 °C		
17	+4.0 °C				

4) Auto restart

Enables or disables automatic restart after a power interruption.

Function number	Setting value	Setting description	Factory setting
40	00	Enable	◆
	01	Disable	

NOTE: Auto restart is an emergency function such as for power outage etc. Do not attempt to use this function in normal operation. Be sure to operate the unit by remote controller or external device.

5) Room temperature sensor switching

(Only for wired remote controller)

When using the wired remote controller temperature sensor, change the setting to "Both" (01).

Function number	Setting value	Setting description	Factory setting
42	00	Indoor unit	◆
	01	Both	

00: Sensor on the indoor unit is active.

01: Sensors on both indoor unit and wired remote controller are active.

NOTE: Remote controller sensor must be turned on by using the remote controller.

6) Remote controller custom code

(Only for wireless remote controller)

The indoor unit custom code can be changed. Select the appropriate custom code.

Function number	Setting value	Setting description	Factory setting
44	00	A	◆
	01	B	
	02	C	
	03	D	

7) External input control

"Operation/Stop" mode or "Forced stop" mode can be selected.

Function number	Setting value	Setting description	Factory setting
46	00	Operation/Stop mode 1 (Remote controller enabled)	◆
	01	(Setting prohibited)	
	02	Forced stop mode	
	03	Operation/Stop mode 2 (Remote controller disabled)	

8) Room temperature sensor switching (Aux.)

To use the temperature sensor on the wired remote controller only, change the setting to "Wired remote controller" (01).

This function will only work if the function setting 42 is set at "Both" (01).

When the setting value is set to "Both" (00), more suitable control of the room temperature is possible by setting function setting 30 and 31 too.

Function number	Setting value	Setting description	Factory setting
48	00	Both	◆
	01	Wired remote controller	

9) Indoor unit fan control for energy saving for cooling

Enables or disables the power-saving function by controlling the indoor unit fan rotation when the outdoor unit is stopped during cooling operation.

Function number	Setting value	Setting description	Factory setting
49	00	Disable	
	01	Enable	
	02	Remote controller	◆

00: When the outdoor unit is stopped, the indoor unit fan operates continuously following the setting on the remote controller.

01: When the outdoor unit is stopped, the indoor unit fan operates intermittently at a very low speed.

02: Enable or disable this function by remote controller setting.

NOTE: Set to "00" or "01" when connecting a remote controller that cannot set the Fan control for energy saving function or connecting a network converter. To confirm if the remote controller has this setting, refer to the operating manual of each remote controller.

10) Switching functions for external output terminal

Functions of the external output terminal can be switched. For details, refer to “External input and output”.

Function number	Setting value	Setting description	Factory setting
60	00	Operation status	◆
	01—08	(Setting prohibited)	
	09	Error status	
	10	Indoor unit fan operation status	
	11	(Setting prohibited)	
	12	Setpoint attainment status	

11) Special cooling operation

Stabilizes the cooling operation when the outdoor temperature is low.

- Operation mode: Fixed at COOL
- Airflow: Fixed at HIGH
- Set temperature: 24°C to 30°C

Function number	Setting value	Setting description	Factory setting
96	00	Disable	◆
	01	Enable	

NOTES:

- Connect the optional wired remote controller to change the setting value to “Enable” (01).
- Do not use the wireless remote controller after changing the setting value to “Enable” (01).
- If the wired remote controller becomes noncommunicable after setting “Enable” (01), the cooling operation starts automatically.
- If dew condenses on the indoor unit surface after setting “Enable” (01), set the setting value back to “Disable” (00).

11-2. Custom code setting for wireless remote controller

To interconnect the air conditioner and the wireless remote controller, assignment of the custom code for the wireless remote controller is required.

NOTE: Air conditioner cannot receive a signal if the air conditioner has not been set for the custom code.

When 2 or more air conditioners are installed in a room, and the remote controller is operating an air conditioner other than the one you wish to set, change the custom code of the remote controller to operate only the air conditioner you wish to set. (4 selections possible.)

Confirm the setting of the remote controller custom code and the function setting. If these do not match, the remote controller cannot be used to operate for the air conditioner.









1. Press the START/STOP button until only the clock is displayed on the remote controller display.
2. Press the MODE button for at least 5 seconds to display the current custom code. (Initially set to H .)
3. Press the TEMP. (\wedge) (\vee) buttons to change the custom code between $\text{H} \rightarrow \text{b} \rightarrow \text{c} \rightarrow \text{d}$. Match the code on the display to the air conditioner custom code. (Initially set to H .)
4. Press the MODE button again to return to the clock display. The custom code will be changed.

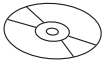
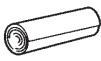

NOTES:

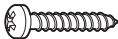
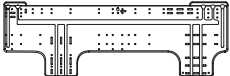

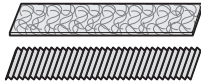

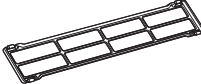
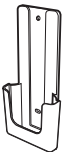
- If no button is pressed within 30 seconds after the custom code is displayed, the system returns to the original clock indicator. In this case, start again from step 1.
- The air conditioner custom code is set to H prior to shipment. To change the custom code, contact your retailer.
- If you do not know the assigned code for the air conditioner, try each of the custom code ($\text{H} \rightarrow \text{b} \rightarrow \text{c} \rightarrow \text{d}$) until you find the code which operates the air conditioner.

12. Accessories

Part name	Exterior	Q'ty	Part name	Exterior	Q'ty
Operating manual		1	Drain hose insulation		1
Operating manual (CD-ROM)		1	Cloth tape		1
Installation manual		1	Tapping screw (large)		8
Wall hook bracket		1	Tapping screw (small)		2
Remote controller		1	Air cleaning filters		1
Battery		2	Filter holder		2
Remote controller holder		1			

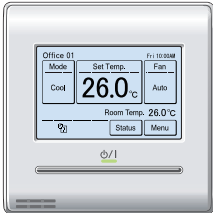
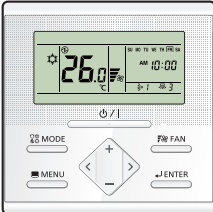
13. Optional parts

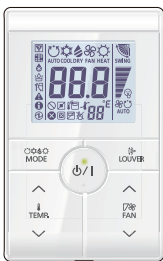





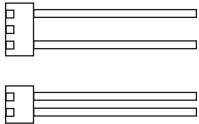
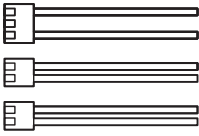

13-1. Controllers

Exterior	Part name	Model name	Summary
	Wired Remote Controller	UTY-RNRYZ*	Easy finger touch operation with LCD panel. Backlit LCD enables easy operation in a dark room. Wire type: Non-polar 2-wire Optional Communication Kit is necessary for installation.
	Wired Remote Controller	UTY-RLRY	High visibility and easy operation. Room temperature can be accurately controlled using the thermo sensor. Wire type: Non-polar 2-wire Optional Communication Kit is necessary for installation.
	Compact Wired Remote Controller	UTY-RCRYZ1	Compact body and easy operation. Room temperature can be accurately controlled using the thermo sensor. Wire type: Non-polar 2-wire Optional Communication Kit is necessary for installation.
	Simple Remote Controller	UTY-RSRY	Compact remote controller concentrates on the basic functions such as Start/Stop, fan control, temperature setting, and operation mode. Wire type: Non-polar 2-wire Optional Communication Kit is necessary for installation.
	Simple Remote Controller	UTY-RHRY	Compact remote controller concentrates on the basic functions such as Start/Stop, fan control, and temperature setting. Wire type: Non-polar 2-wire Optional Communication Kit is necessary for installation.

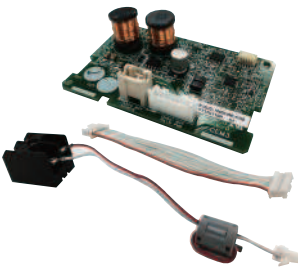
NOTES:

- Available functions may differ by the remote controller. For details, refer to the operation manual.
- When using the group controlling system of the Wired Remote Controller, using WLAN Adapter is prohibited.

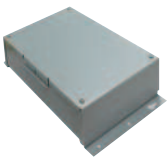
13-2. Others

Exterior	Part name	Model name	Summary
	External Connect Kit	UTY-XWZX	Use to connect with various peripheral devices and air conditioner PCB. Connecting point: CN47 on Main PCB
	External Connect Kit	UTY-XWZXZ5	Required when external device is connected. Connecting point: CN47 on Main PCB
	External Input and Output PCB	UTY-XCSXZ2	Use to connect with external devices and air conditioner PCB. Optional External Connect Kit is necessary for installation. Connecting point: CN65 on Main PCB
	Communication Kit	UTY-TWRXZ2	Use to connect Non-polar 2-core wired remote controller.
	WLAN Adapter	UTY-TFSXF2	Remotely manage an air conditioning system using mobile devices such as smartphones and tablets. Appropriate application for each region is required to use this option. For details, contact FGL sales company. Connecting point: Main PCB via USB connector
	Modbus Converter	UTY-VMSX	For connection between indoor unit with UART interface and a Modbus open network. Connecting point: CN65 on Main PCB
	KNX Converter	UTY-VKSX	For connection between indoor unit with UART interface and a KNX open network. Connecting point: CN65 on Main PCB
	Network Converter	UTY-VTGX	This converter is required when connecting single split system to VRF network system. Use the terminal for wired remote controller.
	Network Converter (AC power supply)	UTY-VTGXV	This converter is required when connecting single split system to VRF network system. Use the terminal for wired remote controller.
	External Switch Controller	UTY-TERX	Air conditioner switching can be controlled by connecting other external sensor switches. Use the terminal for wired remote controller.

Part 2. OUTDOOR UNIT

SINGLE TYPE:

AOYH30KMTB

AOYH36KMTB

1. Specifications

Type			Inverter heat pump	
Model name			AOYH30KMTB	AOYH36KMTB
Power supply			230 V ~ 50 Hz	
Power supply intake			Outdoor unit	
Available voltage range			198—264 V	
Starting current			10.2	13.9
Fan	Airflow rate	Cooling	3,750	
		Heating	3,750	
	Type × Qty		Propeller × 1	
	Motor output		100	
Sound pressure level*1	Cooling	dB (A)	53	55
	Heating		55	55
Sound power level	Cooling	dB (A)	68	70
	Heating		69	70
Heat exchanger type	Dimensions (H × W × D)		Main1: 756 × 905 × 18.19 Main2: 756 × 905 × 18.19	
	Fin pitch		1.45	
	Rows × Stages		1 × 36	
	Pipe type		Copper	
	Fin	Type (Material)	Aluminum	
		Surface treatment	Blue fin	
Compressor	Type × Qty		DC Twin rotary × 1	
	Motor output		1,500	
Refrigerant	Type (Global warming potential)		R32 (675)	
	Factory charge		g	
Refrigerant oil	Type		FW68D	
	Amount		cm ³	
			600	
Enclosure	Material		Steel sheet	
	Color		Beige Approximate color of Munsell 10YR 7.5/1.0	
Dimensions (H × W × D)	Net		788 × 940 × 320	
	Gross		966 × 1,027 × 445	
Weight	Net		52	
	Gross		62	
Connection pipe	Size	Liquid	Ø9.52 (3/8)	
		Gas	Ø15.88 (5/8)	
	Method		Flare	
	Pre-charge length		30	
	Max. length		50	
	Max. height difference		30	
Operation range	Cooling	°C	-15 to 46	
	Heating		-15 to 24	
Drain hose	Material		LDPE	
	Size		mm	
Ø13.0 (I. D.), Ø16.0 to Ø16.7 (O. D.)				
NOTES: <ul style="list-style-type: none"> Specifications are based on the following conditions: <ul style="list-style-type: none"> Cooling: Indoor temperature of 27 °CDB/19 °CWB, and outdoor temperature of 35 °CDB/24 °CWB. Heating: Indoor temperature of 20 °CDB/15 °CWB, and outdoor temperature of 7 °CDB/6 °CWB. Pipe length: 5.0 m, Height difference: 0 m. (Between outdoor unit and indoor unit.) Protective function might work when using it outside the operation range. *1: Sound pressure level <ul style="list-style-type: none"> Measured values in manufacturer's anechoic chamber. Because of the surrounding sound environment, the sound levels measured in actual installation conditions might be higher than the specified values here. This data is based on EN 14511 standard. 				

2. Dimensions

2-1. Models: AOYH30KMTB and AOYH36KMTB

Unit: mm

OUTDOOR UNIT
AOYH30-36KMTB

OUTDOOR UNIT
AOYH30-36KMTB

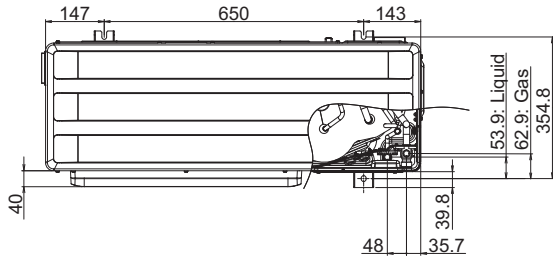

Top view

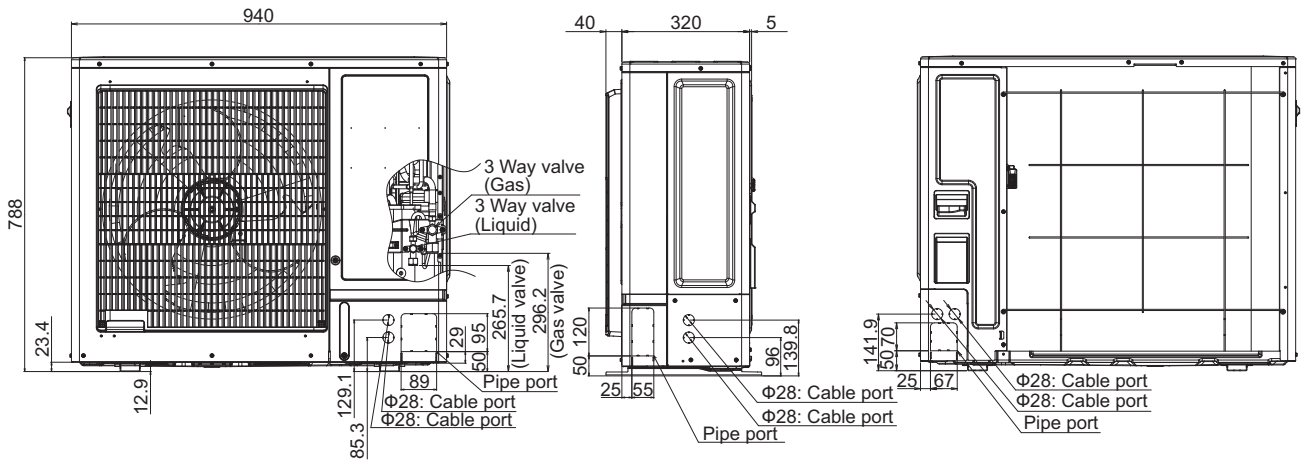

Front view

Side view

Rear view

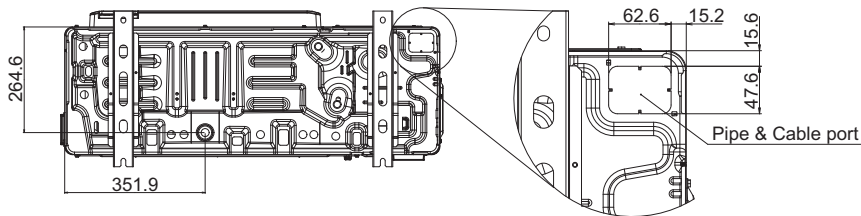

Bottom view

3. Installation space

3-1. Models: AOYH30KMTB and AOYH36KMTB

■ Space requirement

Provide sufficient installation space for product safety.

⚠ CAUTION

Keep the space shown in the installation examples.

If the installation is not performed accordingly, it could cause a short circuit and result in a lack of operating performance.

● Single outdoor unit installation

- When the upper space is open:

Unit: mm

When there are obstacles at the rear only.

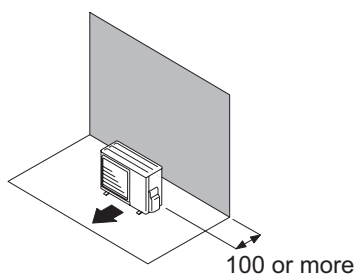

When there are obstacles at the rear and sides.

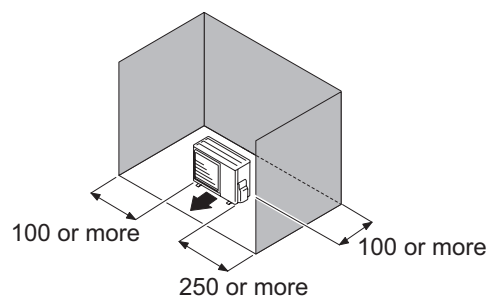

When there are obstacles at the front only.

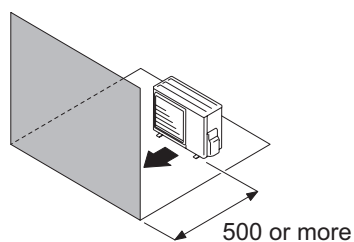

When there are obstacles at the front and rear.

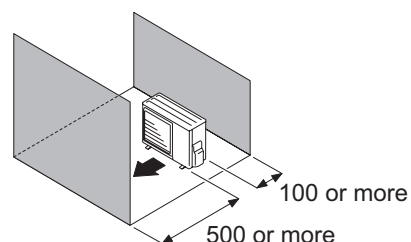

• When an obstruction in the upper space:

Unit: mm

When there are obstacles at the rear and above.

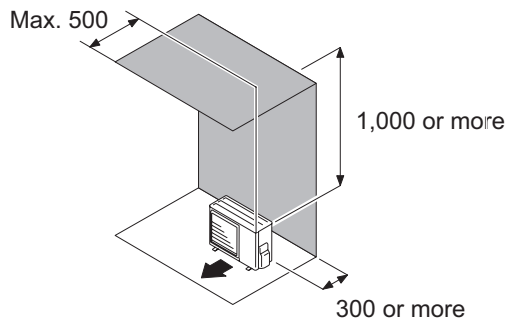

When there are obstacles at the rear, sides, and above.

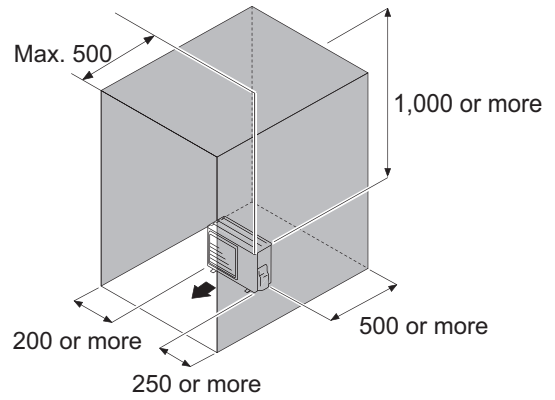

OUTDOOR UNIT
AOYH30-36KMTB

OUTDOOR UNIT
AOYH30-36KMTB

● Multiple outdoor unit installation

- Provide at least 250 mm of space between the outdoor units if multiple units are installed.
- When routing the piping from the side of an outdoor unit, provide space for piping.
- No more than 3 units must be installed side by side.
When 4 units or more are arranged in a line, provide the space as shown in the following example **“When an obstruction in the upper space:”**.

- **When the upper space is open:**

Unit: mm

When there are obstacles at the rear only.

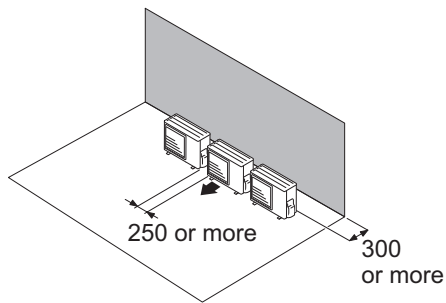

When there are obstacles at the front only.

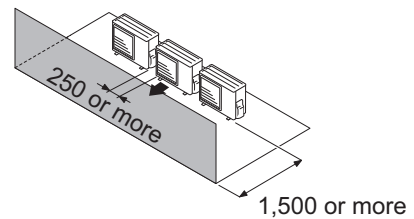

When there are obstacles at the front and rear.

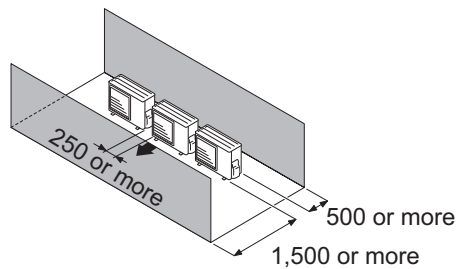

- **When an obstruction in the upper space:**

Unit: mm

When there are obstacles at the rear and above.

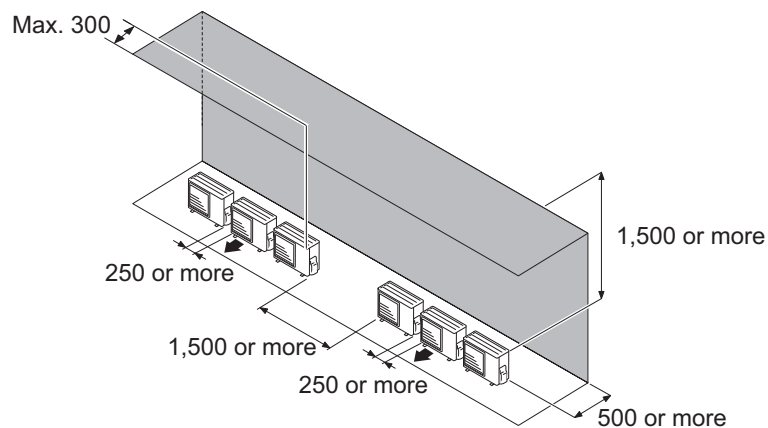

● Outdoor unit installation in multi-row

Unit: mm

Single parallel unit arrangement

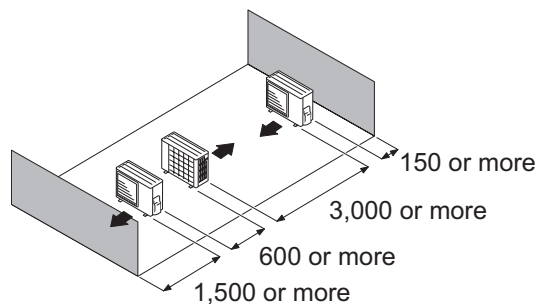

Multiple parallel unit arrangement

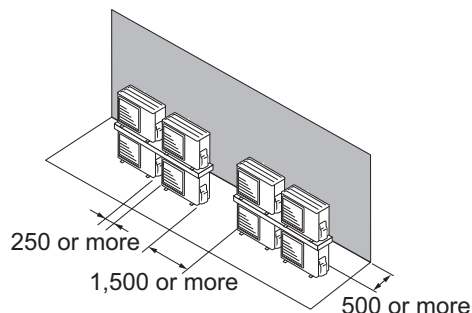
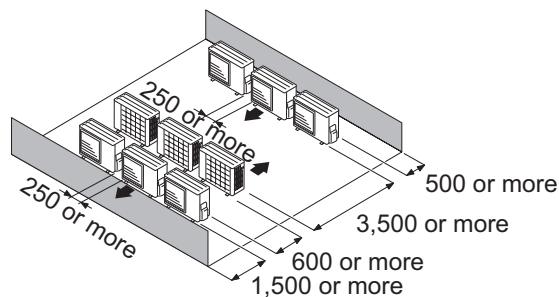

NOTES:

- If the space is larger than stated above, the condition will be the same as when there is no obstacle.
- Height above the floor level should be 50 mm or more.
- When installing the outdoor unit, be sure to open the front and left side to obtain better operation efficiency.

⚠ CAUTION

- Do not install the outdoor unit in two-stage where the drain water could freeze. Otherwise the drainage from the upper unit may form ice and cause a malfunction of the lower unit.
- When the outdoor temperature is 0 °C or less, do not use the accessory drain pipe and drain cap. If the drain pipe and drain cap are used, the drain water in the pipe may freeze in extremely cold climate. (For reverse cycle model only.)
- In area with heavy snowfall, if the inlet and outlet of the outdoor unit is blocked with snow, it might become difficult to get warm, and it is likely to cause product malfunction. Construct a canopy and a pedestal, or place the unit on a high stand that is locally installed.

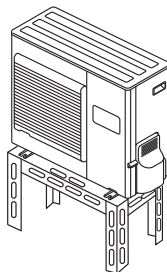

4. Refrigerant circuit

4-1. Models: AOYH30KMTB and AOYH36KMTB

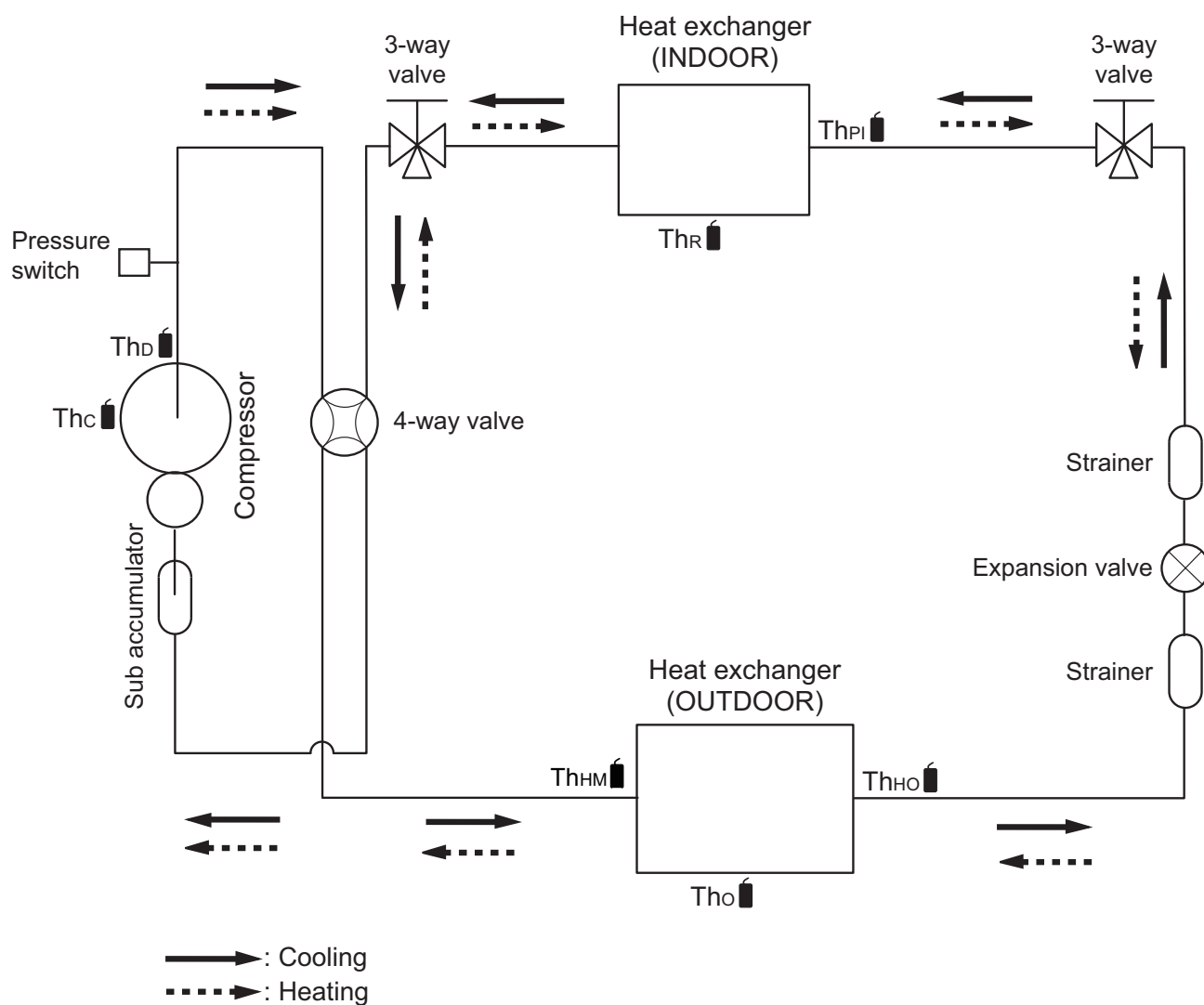

Th_c : Thermistor (Compressor temperature)

Th_d : Thermistor (Discharge temperature)

Th_{HM} : Thermistor (Heat exchanger middle temperature)

Th_o : Thermistor (Outdoor temperature)

Th_{Ho} : Thermistor (Heat exchanger out temperature)

Th_{PI} : Thermistor (Pipe temperature)

Th_R : Thermistor (Room temperature)

5. Wiring diagrams

5-1. Models: AOYH30KMTB and AOYH36KMTB

OUTDOOR UNIT
AOYH30-36KMTB

OUTDOOR UNIT
AOYH30-36KMTB

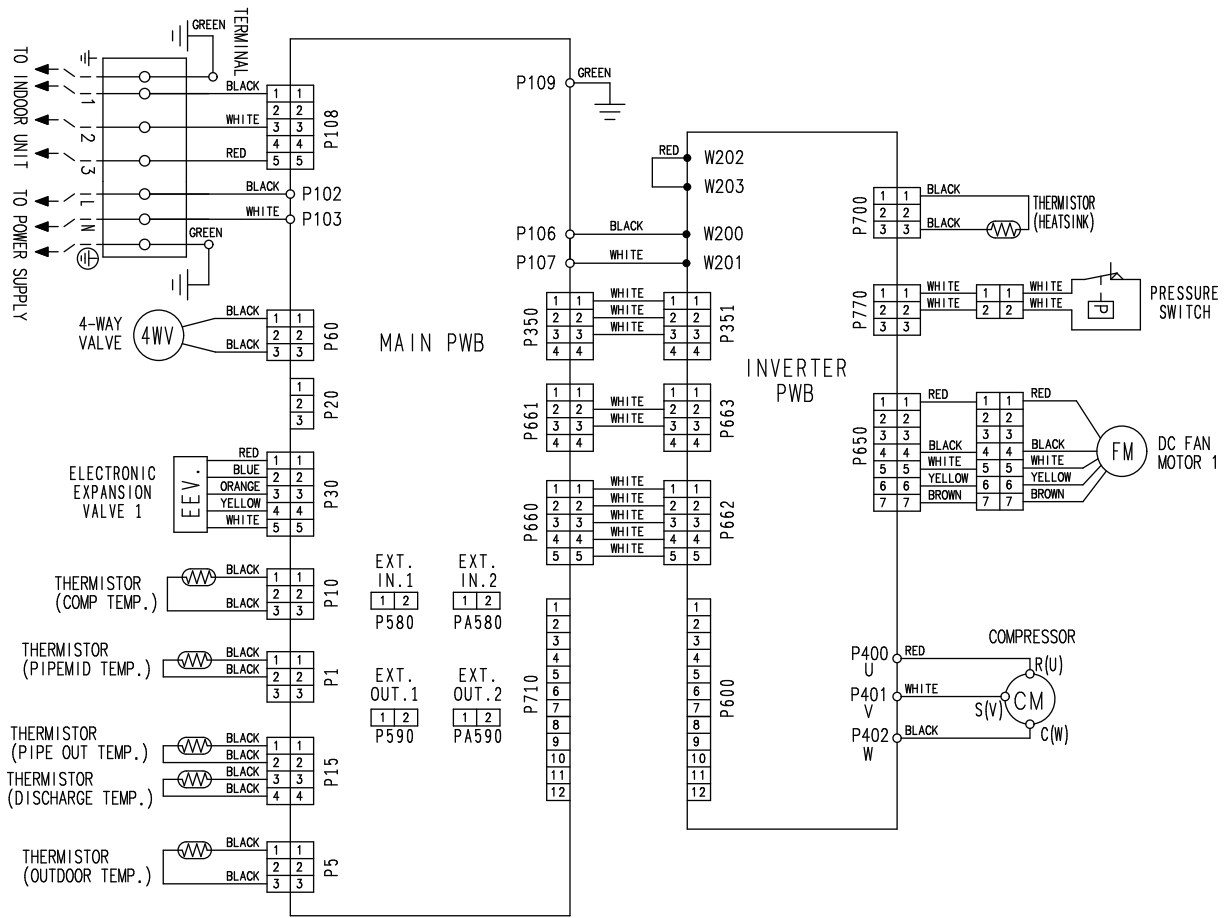

6. Capacity compensation rate for pipe length and height difference

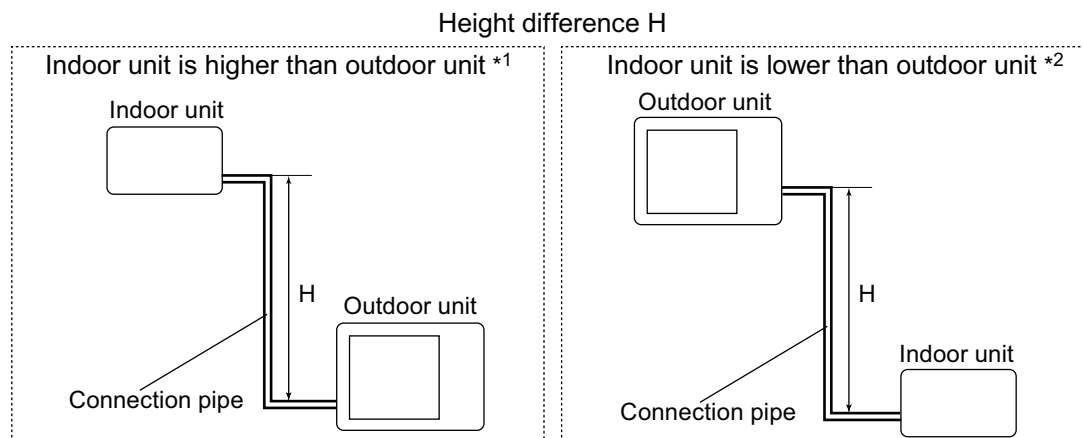

6-1. Model: AOYH30KMTB

NOTE: Values mentioned in the table are calculated based on the maximum capacity.

COOLING			Pipe length (m)						
			5	7.5	10	20	30	40	50
Height difference H (m)	Indoor unit is higher than outdoor unit *1	30	—	—	—	—	0.926	0.916	0.906
		20	—	—	—	0.953	0.942	0.931	0.920
		10	—	—	0.979	0.968	0.958	0.946	0.936
		7.5	—	0.988	0.983	0.972	0.961	0.951	0.939
		5	0.992	0.992	0.987	0.976	0.965	0.954	0.943
Height difference H (m)	Indoor unit is lower than outdoor unit *2	0	1.000	1.000	0.995	0.984	0.973	0.962	0.951
		-5	1.000	1.000	0.995	0.984	0.973	0.962	0.951
		-7.5	—	1.000	0.995	0.984	0.973	0.962	0.951
		-10	—	—	0.995	0.984	0.973	0.962	0.951
		-20	—	—	—	0.984	0.973	0.962	0.951
		-30	—	—	—	—	0.973	0.962	0.951

HEATING			Pipe length (m)						
			5	7.5	10	20	30	40	50
Height difference H (m)	Indoor unit is higher than outdoor unit *1	30	—	—	—	—	0.931	0.914	0.899
		20	—	—	—	0.954	0.931	0.914	0.899
		10	—	—	0.990	0.954	0.931	0.914	0.899
		7.5	—	1.000	0.990	0.954	0.931	0.914	0.899
		5	1.000	1.000	0.990	0.954	0.931	0.914	0.899
Height difference H (m)	Indoor unit is lower than outdoor unit *2	0	1.000	1.000	0.990	0.954	0.931	0.914	0.899
		-5	0.995	0.995	0.986	0.949	0.926	0.909	0.895
		-7.5	—	0.993	0.983	0.946	0.924	0.907	0.892
		-10	—	—	0.981	0.944	0.921	0.904	0.890
		-20	—	—	—	0.935	0.912	0.895	0.881
		-30	—	—	—	—	0.903	0.886	0.872

6-2. Model: AOYH36KMTB

NOTE: Values mentioned in the table are calculated based on the maximum capacity.

COOLING			Pipe length (m)						
			5	7.5	10	20	30	40	50
Height difference H (m)	Indoor unit is higher than outdoor unit *1	30	—	—	—	—	0.902	0.882	0.862
		20	—	—	—	0.938	0.917	0.897	0.876
		10	—	—	0.973	0.953	0.933	0.912	0.891
		7.5	—	0.988	0.977	0.957	0.936	0.916	0.895
		5	0.992	0.992	0.981	0.961	0.940	0.919	0.898
	Indoor unit is lower than outdoor unit *2	0	1.000	1.000	0.989	0.968	0.947	0.926	0.905
		-5	1.000	1.000	0.989	0.968	0.947	0.926	0.905
		-7.5	—	1.000	0.989	0.968	0.947	0.926	0.905
		-10	—	—	0.989	0.968	0.947	0.926	0.905
		-20	—	—	—	0.968	0.947	0.926	0.905
		-30	—	—	—	—	0.947	0.926	0.905

HEATING			Pipe length (m)						
			5	7.5	10	20	30	40	50
Height difference H (m)	Indoor unit is higher than outdoor unit *1	30	—	—	—	—	0.978	0.968	0.958
		20	—	—	—	0.988	0.978	0.968	0.958
		10	—	—	0.998	0.988	0.978	0.968	0.958
		7.5	—	1.000	0.998	0.988	0.978	0.968	0.958
		5	1.000	1.000	0.998	0.988	0.978	0.968	0.958
	Indoor unit is lower than outdoor unit *2	0	1.000	1.000	0.998	0.988	0.978	0.968	0.958
		-5	0.995	0.995	0.993	0.983	0.973	0.963	0.953
		-7.5	—	0.993	0.991	0.981	0.971	0.961	0.951
		-10	—	—	0.988	0.978	0.968	0.958	0.948
		-20	—	—	—	0.968	0.958	0.949	0.939
		-30	—	—	—	—	0.949	0.939	0.929

7. Additional charge calculation

7-1. Models: AOYH30KMTB and AOYH36KMTB

Refrigerant type		R32
Factory charge amount	g	1,900

■ Refrigerant charge

Total pipe length	m	30 or less	40	50 (Max.)	40 g/m
Additional charge amount	g	0	400	800	

8. Airflow

8-1. Models: AOYH30KMTB and AOYH36KMTB

● Cooling

m ³ /h	3,750
l/s	1,042
CFM	2,207

● Heating

m ³ /h	3,750
l/s	1,042
CFM	2,207

9. Operation noise (sound pressure)

9-1. Noise level curve

Model: AOYH30KMTB

Cooling

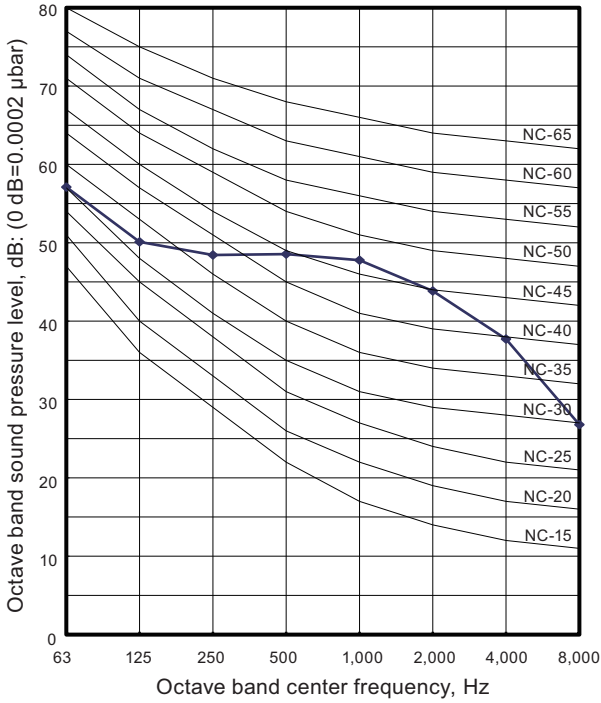

Heating

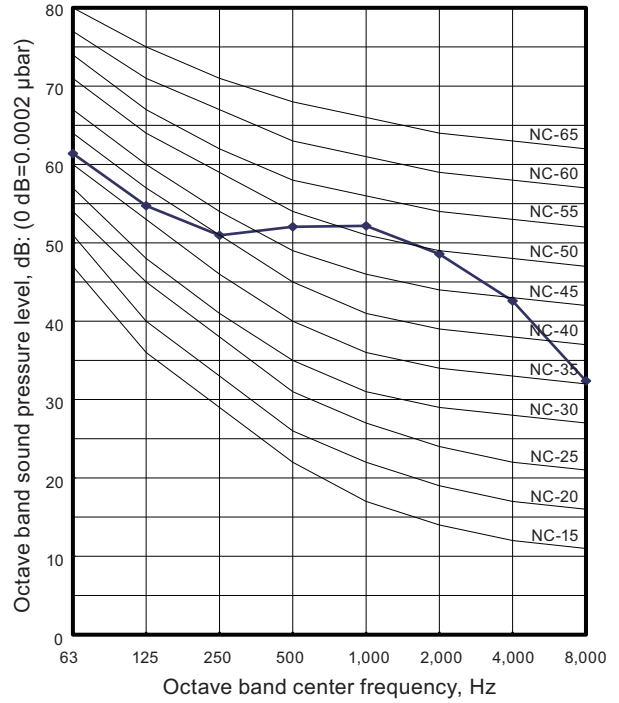

Model: AOYH36KMTB

Cooling

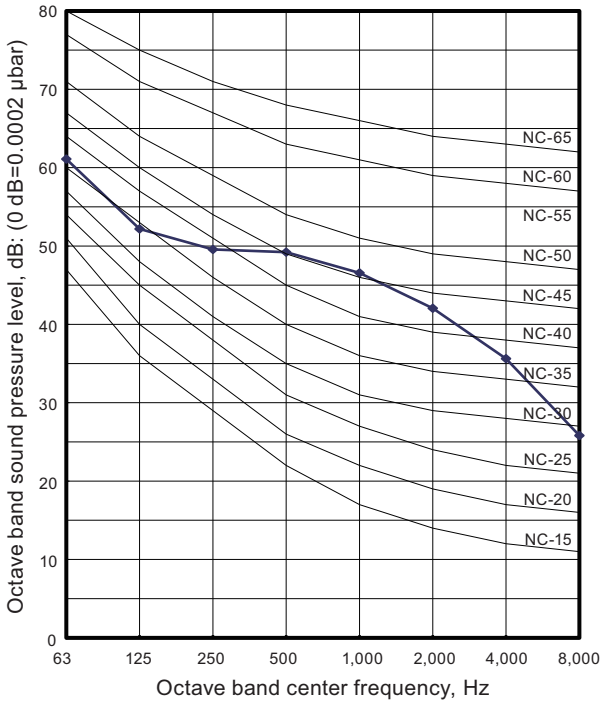

Heating

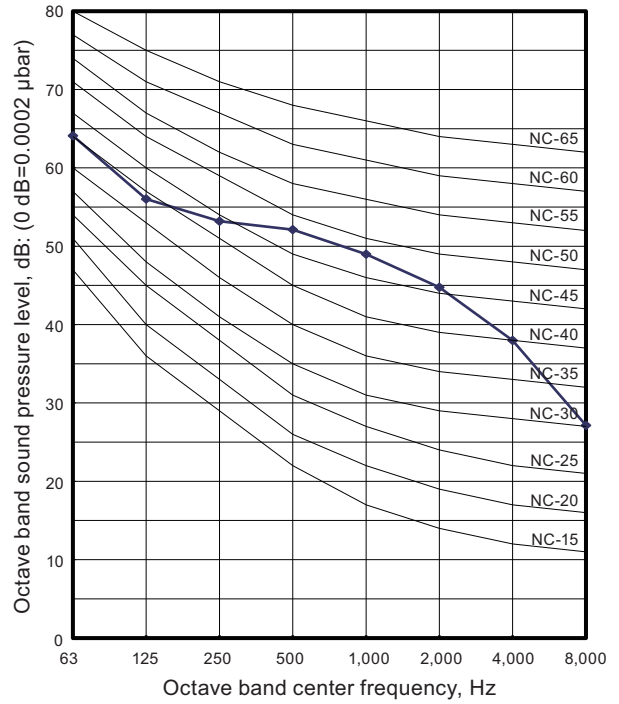

OUTDOOR UNIT
AOYH30-36KMTB

OUTDOOR UNIT
AOYH30-36KMTB

9-2. Sound level check point

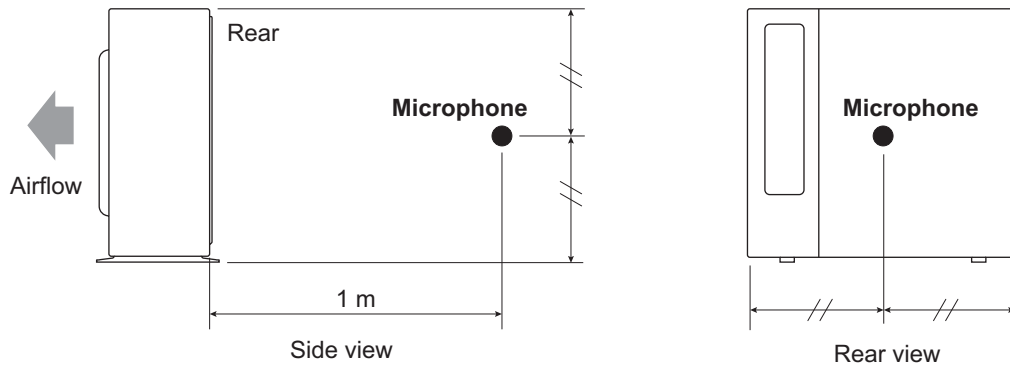

NOTE: Detailed shape of the actual outdoor unit might be slightly different from the one illustrated above.

10. Electrical characteristics

Item		Unit	Model		
			AOYH30KMTB	AOYH36KMTB	
Power supply	Voltage	V	230 ~		
	Frequency	Hz	50		
Max operating current* ¹		A	21.0	21.5	
Starting current		A	10.2	13.9	
Wiring spec.* ²	Circuit breaker current		25		
	Power cable		4.0		
	Connection cable* ³	Cross-sectional area	mm ²	1.5	
		Limited wiring length	m	51	

*1: Maximum current is the total current of the indoor unit and the outdoor unit.

*2: Selected sample based on Japan Electrotechnical Standards and Codes Committee E0005. As the regulations of wire size and circuit breaker differ in each country or region, select appropriate devices complied to the regional standard.

*3: Limit voltage drop to less than 2%. Increase conductor size if voltage drop is 2% or more.

11. Safety devices

Type of protection	Protection form		Model	
			AOYH30KMTB	AOYH36KMTB
Circuit protection	Current fuse (Main PCB)		250 V, 30 A 250 V, 3.15 A 250 V, 10 A × 2	
Fan motor protection	Thermal protection program	Activate	122 ±9 °C Fan motor stop	
		Reset	107—126 °C Fan motor restart	
Compressor protection	Thermal protection program (Discharge temp.)	Activate	110 °C Compressor stop	
		Reset	After 7 minutes Compressor restart	
	Thermal protection program (Compressor temp.)	Activate	108 °C Compressor stop	
		Reset	80 °C or less Compressor restart	

12. External input and output

With using external input and output functions, this product can be operated inter-connectedly with an external device.

Connector	Input	Output	Remarks
P580	Low noise mode	—	See external input/output settings for details.
PA580	Peak cut mode	—	
P590	—	Error status	
PA590	—	Compressor status	

12-1. External input

With using external input function, on/off status of “Low noise mode” and “Peak cut mode” can be specified by the external signal.

■ Low noise mode

In following condition, the operating noise of the outdoor unit reduces comparing from the one in normal operating condition:

The air conditioner is set to the “Low noise mode” when closing the contact input of a commercial timer or on/off switch to a connector on the control PCB of the outdoor unit.

NOTE: Product performance may drop depending on some conditions such as the outdoor temperature.

• Circuit diagram example

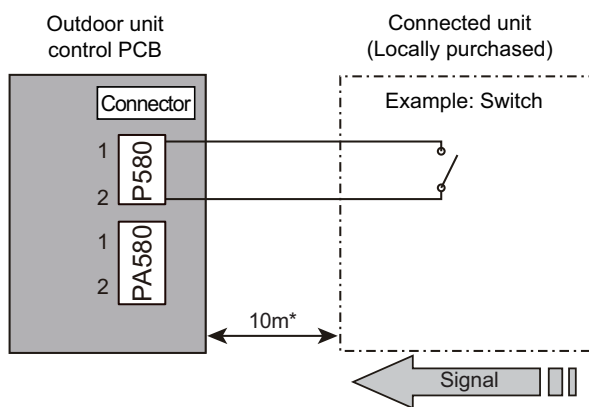

- Contact capacity: DC 24 V or more, 10 mA or more.
- *: Make the distance from the PCB to the connected unit within 10 m.
- Construct a circuit as shown in this figure with using optional parts mentioned below.
- Input signal: On in “Low noise mode”
- Input signal: Off in normal operation
- To set the level of “Low noise mode,” refer to ["Low noise mode"](#) on page 64 (under “Local setting procedure”).

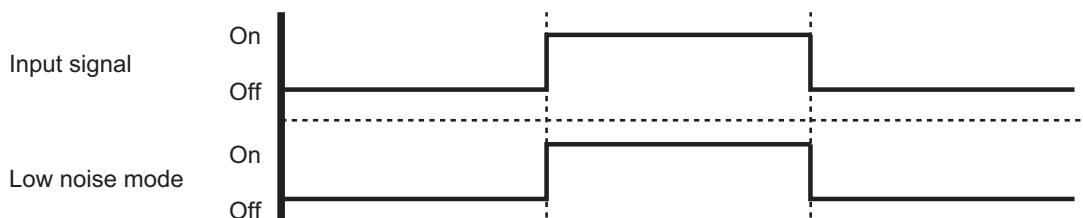

• Optional part

Part name	Model name	Exterior
External Connect Kit	UTY-XWZXZ3	External input wire 

■ Peak cut mode

By performing following on-site work, operation that suppresses the current value can be enabled: The air conditioner is set to the “Peak cut mode” when closing the contact input of a commercial timer or on/off switch to a connector on the control PCB of the outdoor unit.

• Circuit diagram example

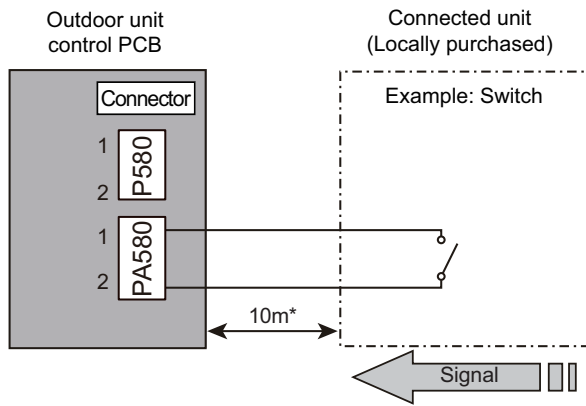

- Contact capacity: DC 24 V or more, 10 mA or more.
- *: Make the distance from the PCB to the connected unit within 10 m.
- Construct a circuit as shown in this figure with using optional parts mentioned below.
- Input signal: On in “Peak cut mode”
- Input signal: Off in normal operation
- To set the level of “Peak cut mode,” refer to “Peak cut mode” on page 65 (under “Local setting procedure”).

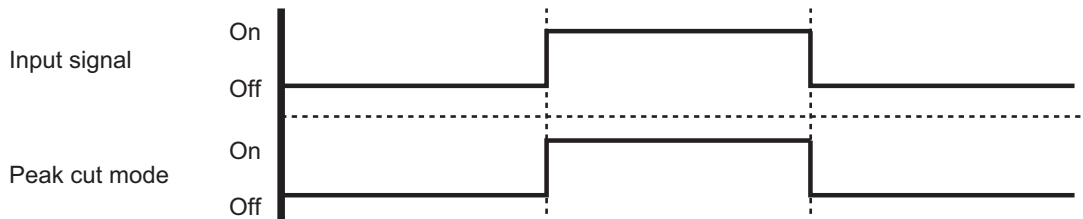

• Optional part

Part name	Model name	Exterior
External Connect Kit	UTY-XWZXZ3	External input wire 

12-2. External output

With using external output function, some status signals are transmitted to the control PCB, and the related LED lamp indicates the status of this product.

■ Error status output

Signal on air conditioner error status is generated when a malfunction occurs.

• Circuit diagram example

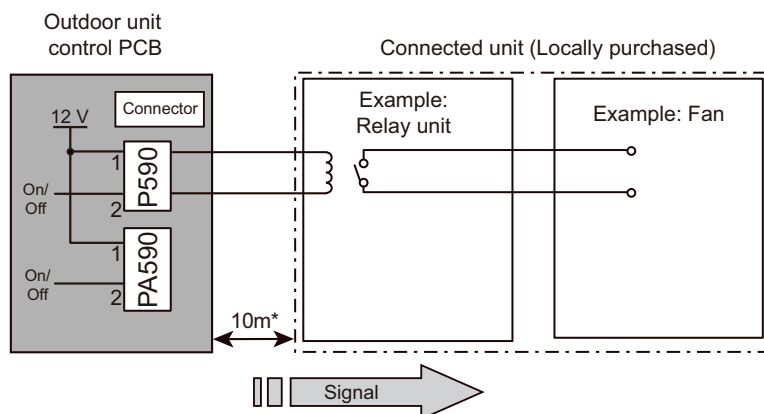

- Output voltage (Vcc): DC 12 V 50 mA or less
- *: Make the distance from the PCB to the connected unit within 10 m.

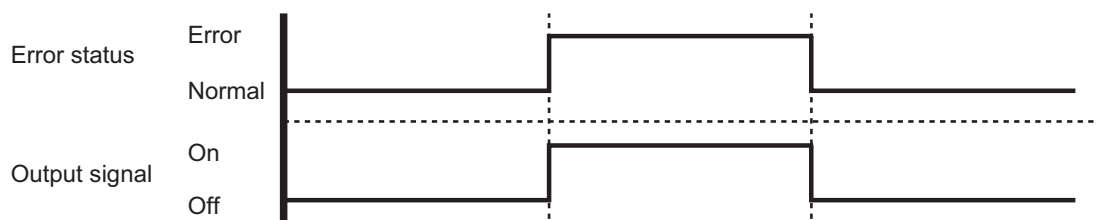

• Optional part

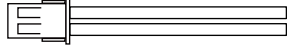
Part name	Model name	Exterior
External Connect Kit	UTY-XWZXZ3	External output wire 

Compressor status output

Signal on compressor operation status is generated when the compressor is running.

• Circuit diagram example

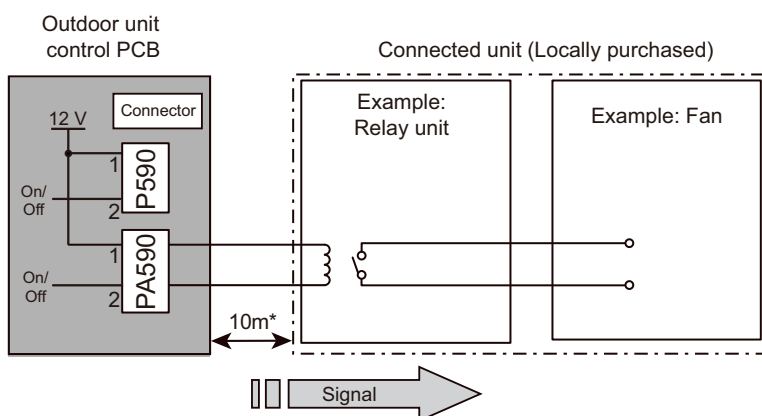

- Output voltage (Vcc): DC 12 V
50 mA or less
- *: Make the distance from the PCB to the connected unit within 10 m.

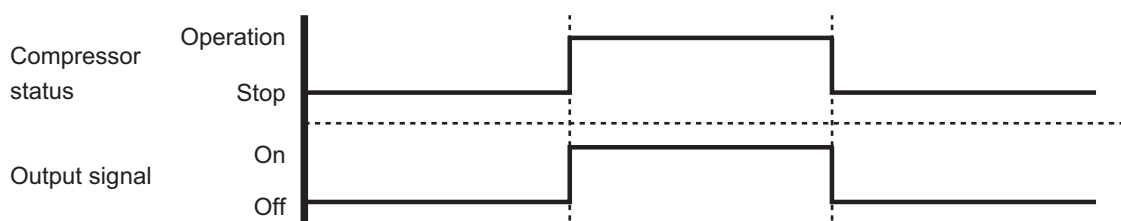

• Optional part

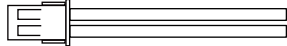
Part name	Model name	Exterior
External Connect Kit	UTY-XWZXZ3	External output wire 

13. Function settings

Perform appropriate function setting locally according to the installation environment.

NOTE: Incorrect settings can cause a product malfunction.

⚠ CAUTION

- Before setting up the switch buttons, discharge the static electricity from your body.
- Never touch the terminals or the patterns on the parts that are mounted on the PCB.

13-1. Control PCB and switch buttons location

Control PCB of the outdoor unit is located as shown in the following figure.

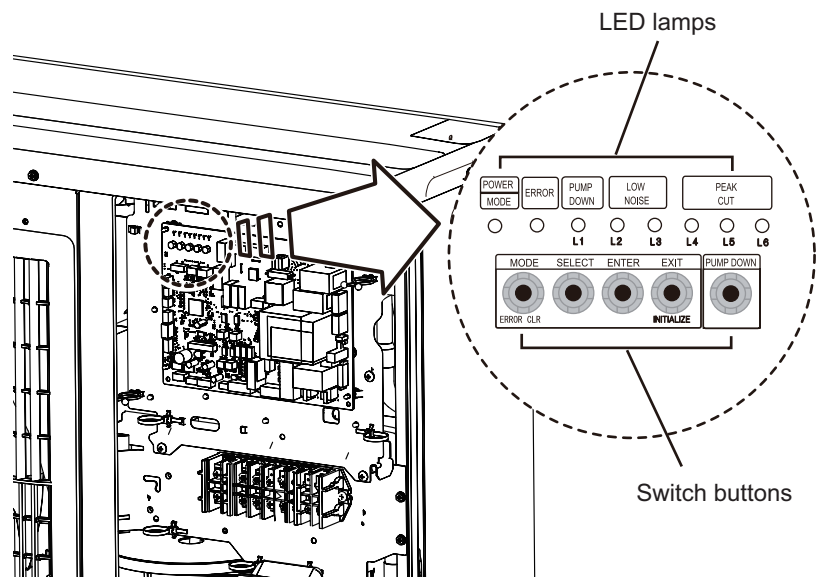

Switch buttons and the functions

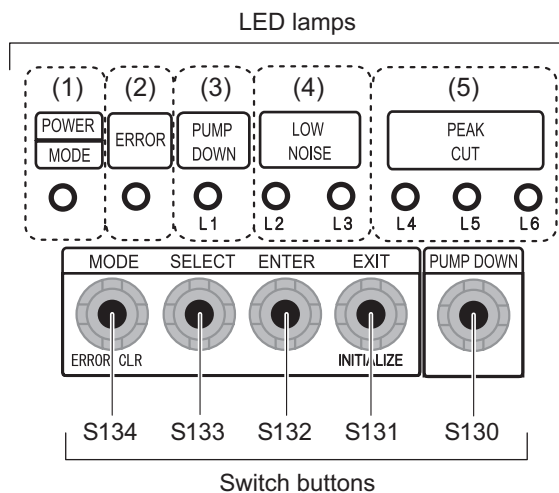

LED lamp			Function or operation method
(1)	POWER/MODE	Green	Lights on while power on. Blinks to show the local setting on the outdoor unit or the error code.
(2)	ERROR	Red	Blinks during error operation.
(3)	PUMP DOWN (L1)	Orange	Lights on during pump down operation.
(4)	LOW NOISE MODE (L2 and L3)	Orange	Lights on during "Low noise mode" when local setting is activated. (Light pattern of L2 and L3 indicates the low noise level.)
(5)	PEAK CUT MODE (L4, L5, and L6)	Orange	Lights on during "Peak cut mode" when local setting is activated. (Light pattern of L4, L5, and L6 indicates the peak cut level.)

Switch button			Function or operation method
S134	MODE		Switches between "Local setting" and "Error code display".
S133	SELECT		Switches between the individual "Local settings" and the "Error code displays".
S132	ENTER		Switches between the individual "Local settings" and the "Error code displays".
S131	EXIT		Returns to "Operation status display".
S130	PUMP DOWN		Starts the pump down operation.

13-2. Local setting procedure

NOTE: Before performing the function setting, be sure to stop the operation of the air conditioner.

Low noise mode

1. Press the MODE switch button (S134) for 3 seconds or more to switch to "Local setting mode".
2. After confirming the LED lamp of POWER/MODE blinks 9 times, press the ENTER switch button (S132).

POWER MODE	ERROR	PUMP DOWN (L1)	LOW NOISE (L2) (L3)		PEAK CUT (L4) (L5) (L6)		
Blinks (9 times)	○	○	○	○	○	○	○

Sign "○": Lights off

3. Press the SELECT switch button (S133), and adjust the LED lamp as shown below. Then the LED lamp indicates the current setting.

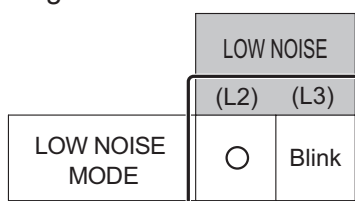

4. Press the ENTER switch button (S132).

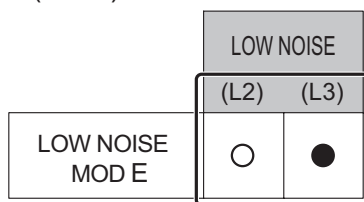

Sign "●": Lights on

5. Press the SELECT switch button (S133), and adjust the LED lamps as shown below.

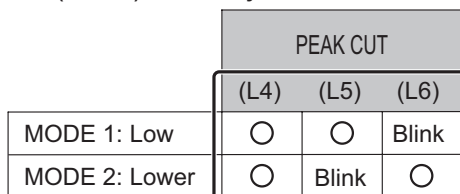

6. Press the ENTER switch button (S132) and fix it.

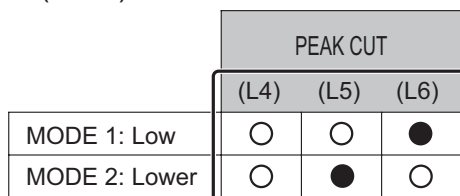

7. To return to "Operating status display (Normal operation)", press the EXIT switch button (S131).

In case of missing how many times you pressed the SELECT and ENTER switch buttons:

1. To return to "Operation status display (Normal operation)", press the EXIT switch button once.
2. Restart from the beginning of setting procedure.

■ Peak cut mode

1. Press the MODE switch button (S134) for 3 seconds or more to switch to “Local setting mode”.
2. After confirming the LED lamp of POWER/MODE blinks 9 times, press the ENTER switch button (S132).

POWER MODE	ERROR	PUMP DOWN (L1)	LOW NOISE		PEAK CUT		
			(L2)	(L3)	(L4)	(L5)	(L6)
Blinks (9 times)	○	○	○	○	○	○	○

Sign “○”: Lights off

3. Press the SELECT switch button (S133), and adjust the LED lamp as shown below. Then the LED lamp indicates the current setting.

		LOW NOISE	
		(L2)	(L3)
PEAK CUT MODE	Blink	○	

4. Press the ENTER switch button (S132).

		LOW NOISE	
		(L2)	(L3)
PEAK CUT MODE	●	○	

Sign “●”: Lights on

5. Press the SELECT switch button (S133), and adjust the LED lamps as shown below.

	PEAK CUT		
	(L4)	(L5)	(L6)
0 % of rated input ratio	○	○	Blink
50 % of rated input ratio	○	Blink	○
75 % of rated input ratio	○	Blink	Blink
100 % of rated input ratio	Blink	○	○

6. Press the ENTER switch button (S132) and fix it.





	PEAK CUT		
	(L4)	(L5)	(L6)
0 % of rated input ratio	○	○	●
50 % of rated input ratio	○	●	○
75 % of rated input ratio	○	●	●
100 % of rated input ratio	●	○	○

7. To return to “Operating status display (Normal operation)”, press the EXIT switch button (S131).

NOTE: When pressed number is lost during setting, you must redo the setting procedure. Return to “Operation status display (Normal operation)” by pressing the EXIT switch button once, and restart from the beginning of the setting procedure.

14. Accessories

14-1. Models: AOYH30KMTB and AOYH36KMTB

Part name	Exterior	Qty	Part name	Exterior	Qty
Installation manual		1	Drain cap		3
Drain pipe		1	One-touch bush		2

15. Optional parts

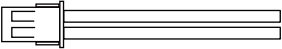
Exterior	Part name	Model name	Summary
	External Connect Kit	UTY-XWZXZ3	Use to operate the external input and output functions of outdoor unit.